

HUD-1 Universal anchor

	Anchor version	Benefits
	HUD-1	<ul style="list-style-type: none"> - fast setting - flexibility of screw length - an anchor for every base material

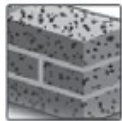

Concrete



Solid brick



Hollow brick

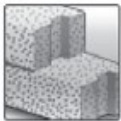

Autoclaved
aerated
concrete



Drywall

Basic loading data (for a single anchor)

All data in this section applies to

- Correct setting (See setting instruction)
- Load data are only valid for the specified woodscrew type
- No edge distance and spacing influence
- Base material as specified in the table
- Minimum base material thickness

Characteristic resistance

Anchor size	Screw type ^{d)}	5x25		6x30		8x40		10x50		12x60	14x70
		W Size 4 DIN 96	C Size 4	W Size 5 DIN 96	C Size 5	W Size 6 DIN 96	C Size 6	W Size 8 DIN 96	C Size 8	W Size 10 DIN 571	W Size 12 DIN 571
Concrete ≥ C16/20	N _{Rk} [kN]	1,5	0,5	2,75	1,75	4,25	2,5	7	-	10	15
	V _{Rk} [kN]	2	-	4,5	-	6,25	-	11	-	15	28
Solid clay brick Mz 20	N _{Rk} [kN]	0,85	0,3	1,75	0,75	3	1,75	4	-	5	5 ^{a)}
	V _{Rk} [kN]	1,2	-	1,5	-	2,2	-	-	-	-	-
Solid sand-lime brick KS 12	N _{Rk} [kN]	1,25	0,75	2,5	1,5	4,25	2	5	-	7,5	7,5 ^{a)}
	V _{Rk} [kN]	1,25	-	2,8	-	3,7	-	6,6	-	-	-
Hollow clay brick HlzB 12	N _{Rk} [kN]	0,4	0,25	0,5	0,4	1	0,6	1,25	-	1,4	1,6
	V _{Rk} [kN]	1,15	-	1,75	-	-	-	-	-	-	-
Hollow clay brick HlzB 12 – 15mm plastered	N _{Rk} [kN]	0,4	0,25	0,75	0,5	1,25	0,75	1,5	-	1,75	2
	V _{Rk} [kN]	1,15	-	1,75	-	-	-	-	-	-	-
Autoclaved aerated concrete AAC 2	N _{Rk} [kN]	0,3	0,2	0,5	0,3	0,75	0,5	1	-	1,25	1,5
	V _{Rk} [kN]	0,2	-	0,25	-	0,4	-	-	-	-	-
Autoclaved aerated concrete AAC 4	N _{Rk} [kN]	0,5	0,3	0,75	0,5	1,5	1	2	-	2,5	3
	V _{Rk} [kN]	0,65	-	0,9	-	1,5	-	-	-	-	-
Gypsum board Thickness 12,5mm	N _{Rk} [kN]	0,2	0,3	0,25	0,4	0,3	0,5	-	0,75 ^{b)}	-	-
	V _{Rk} [kN]	0,45	-	0,7	-	-	-	-	-	-	-
Gypsum board Thickness 2x12,5mm	N _{Rk} [kN]	0,3	0,3	0,4	0,4	0,5	0,5	0,75 ^{b)}	1 ^{b)}	1,5 ^{c)}	-
	V _{Rk} [kN]	0,45	-	0,7	-	-	-	-	-	-	-
Fibre reinforced gypsum board Thickness 12,5mm	N _{Rk} [kN]	0,45	-	0,6	-	0,9	-	-	-	-	-
	V _{Rk} [kN]	0,72	-	0,96	-	1,44	-	-	-	-	-
Fibre reinforced gypsum board Thickness 2x12,5mm	N _{Rk} [kN]	0,45	-	1,2	-	1,8	-	2,1	-	-	-
	V _{Rk} [kN]	0,72	-	1,92	-	2,88	-	3,36	-	-	-

a) only with screw diameter 6mm

b) only with screw diameter 8mm

c) only with screw diameter 10mm

d) Screw type: W: Wood-screw C: Chipboard screw

Load data are valid for the mentioned woodscrew type, if other types or different screws are used the load capacity may decrease.

Design resistance

Anchor size	Screw type ^{d)}	5x25		6x30		8x40		10x50		12x60	14x70
		W Size 4 DIN 96	C Size 4	W Size 5 DIN 96	C Size 5	W Size 6 DIN 96	C Size 6	W Size 8 DIN 96	C Size 8	W Size 10 DIN 571	W Size 12 DIN 571
Concrete ≥ C16/20	N _{Rd} [kN]	0,42	0,14	0,77	0,49	1,19	0,70	1,96		2,80	4,20
	V _{Rd} [kN]	0,56		1,26		1,75		3,08		4,20	7,84
Solid clay brick Mz 20	N _{Rd} [kN]	0,24	0,08	0,49	0,21	0,84	0,49	1,12		1,40	1,40 ^{c)}
	V _{Rd} [kN]	0,34		0,42		0,62					
Solid sand-lime brick KS 12	N _{Rd} [kN]	0,35	0,21	0,70	0,42	1,19	0,56	1,40		2,10	2,10 ^{c)}
	V _{Rd} [kN]	0,35		0,78		1,04		1,85			
Hollow clay brick HlzB 12	N _{Rd} [kN]	0,11	0,07	0,14	0,11	0,28	0,17	0,35		0,39	0,45
	V _{Rd} [kN]	0,32		0,49							
Hollow clay brick HlzB 12 – 15mm plastered	N _{Rd} [kN]	0,11	0,07	0,21	0,14	0,35	0,21	0,42		0,49	0,56
	V _{Rd} [kN]	0,32		0,49							
Autoclaved aerated concrete AAC 2	N _{Rd} [kN]	0,08	0,06	0,14	0,08	0,21	0,14	0,28		0,35	0,42
	V _{Rd} [kN]	0,06		0,07		0,11					
Autoclaved aerated concrete AAC 4	N _{Rd} [kN]	0,14	0,08	0,21	0,14	0,42	0,28	0,56		0,70	0,84
	V _{Rd} [kN]	0,18		0,25		0,42					
Gypsum board Thickness 12,5mm	N _{Rd} [kN]	0,06	0,08	0,07	0,11	0,08	0,14		0,21 ^{a)}		
	V _{Rd} [kN]	0,13		0,20							
Gypsum board Thickness 2x12,5mm	N _{Rd} [kN]	0,08	0,08	0,11	0,11	0,14	0,14	0,21 ^{a)}	0,28 ^{a)}	0,42 ^{b)}	
	V _{Rd} [kN]	0,13		0,20							
Fibre reinforced gypsum board Thickness 12,5mm	N _{Rd} [kN]	0,13		0,17		0,25					
	V _{Rd} [kN]	0,20		0,27		0,40					
Fibre reinforced gypsum board Thickness 2x12,5mm	N _{Rd} [kN]	0,13		0,34		0,50		0,59			
	V _{Rd} [kN]	0,20		0,54		0,81		0,94			

a) only with screw diameter 6mm

b) only with screw diameter 8mm

c) only with screw diameter 10mm

d) Screw type: W: Wood-screw C: Chipboard screw

Load data are valid for the mentioned woodscrew type, if other types or different screws are used the load capacity may decrease.

Recommended loads ^{e)}

Anchor size	Screw type ^{d)}	5x25		6x30		8x40		10x50		12x60	14x70
		W	C	W	C	W	C	W	C	W	W
Concrete ≥ C16/20	N _{rec} [kN]	0,3	0,1	0,55	0,35	0,85	0,5	1,4		2	3
	V _{rec} [kN]	0,4		0,9		1,25		2,2		3	5,6
Solid clay brick Mz 20	N _{rec} [kN]	0,17	0,06	0,35	0,15	0,6	0,35	0,8		1	1
	V _{rec} [kN]	0,24		0,3		0,44					
Solid sand-lime brick KS 12	N _{rec} [kN]	0,25	0,15	0,5	0,3	0,85	0,4	1		1,5	1,5
	V _{rec} [kN]	0,25		0,56		0,74		1,32			
Hollow clay brick HlzB 12	N _{rec} [kN]	0,08	0,05	0,1	0,08	0,2	0,12	0,25		0,28	0,32
	V _{rec} [kN]	0,23		0,35							
Hollow clay brick HlzB 12 – 15mm plastered	N _{rec} [kN]	0,08	0,05	0,15	0,1	0,25	0,15	0,3		0,35	0,4
	V _{rec} [kN]	0,23		0,35							
Autoclaved aerated concrete AAC 2	N _{rec} [kN]	0,06	0,04	0,1	0,06	0,15	0,1	0,2		0,25	0,3
	V _{rec} [kN]	0,04		0,05		0,08					
Autoclaved aerated concrete AAC 4	N _{rec} [kN]	0,1	0,06	0,15	0,1	0,3	0,2	0,4		0,5	0,6
	V _{rec} [kN]	0,13		0,18		0,3					
Gypsum board Thickness 12,5mm	N _{rec} [kN]	0,04	0,06	0,05	0,08	0,06	0,1		0,15		
	V _{rec} [kN]	0,09		0,14							
Gypsum board Thickness 2x12,5mm	N _{rec} [kN]	0,06	0,06	0,08	0,08	0,1	0,1	0,15	0,2	0,3	
	V _{rec} [kN]	0,09		0,14							
Fibre reinforced gypsum board Thickness 12,5mm	N _{rec} [kN]	0,09		0,12		0,18					
	V _{rec} [kN]	0,14		0,19		0,29					
Fibre reinforced gypsum board Thickness 2x12,5mm	N _{rec} [kN]	0,09		0,24		0,36		0,42			
	V _{rec} [kN]	0,14		0,38		0,58		0,67			

a) only with screw diameter 6mm

b) only with screw diameter 8mm

c) only with screw diameter 10mm

d) Screw type: W: Wood-screw C: Chipboard screw

Load data are valid for the mentioned woodscrew type, if other types or different screws are used the load capacity may decrease.

e) With overall global safety factor $\gamma = 5$ to the characteristic loads and a partial safety factor of $\gamma = 1,4$ to the design values.

Service temperature range

Hilti HUD-1 universal anchor may be applied in the temperature range given below.

Temperature range	Base material temperature	Maximum long term base material temperature	Maximum short term base material temperature
Temperature range	-40 °C to +80 °C	+50 °C	+80 °C

Max short term base material temperature

Short-term elevated base material temperatures are those that occur over brief intervals, e.g. as a result of diurnal cycling.

Max long term base material temperature

Long-term elevated base material temperatures are roughly constant over significant periods of time.

Materials

Material quality

Part	Material
Plastic sleeve	Polyamide 6

Setting

Installation equipment

Anchor size	5x25	6x30	8x40	10x50	12x60	14x70
Rotary hammer	TE 2 – TE 16					
Other tools	Screwdriver					

Setting instruction

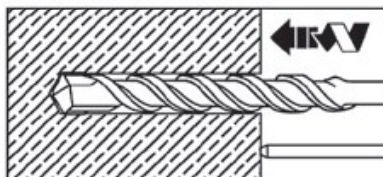

Drill hole with drill bit.

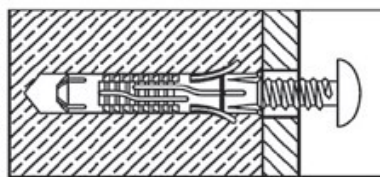

Install anchor.

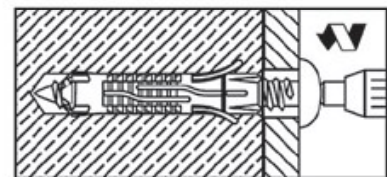

Drive screw into anchor.

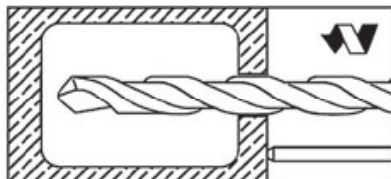

Drill hole with drill bit.

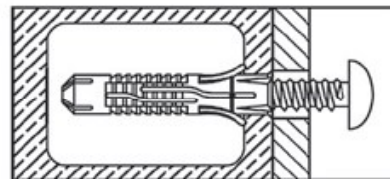

Install anchor.

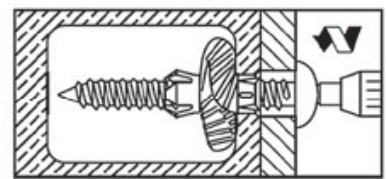

Drive screw into anchor.

Use only for wall and floor applications. Not applicable for ceiling and façade applications.

For detailed information on installation see instruction for use given with the package of the product.

Setting details: depth of drill hole h_1 and effective anchorage depth h_{ef}

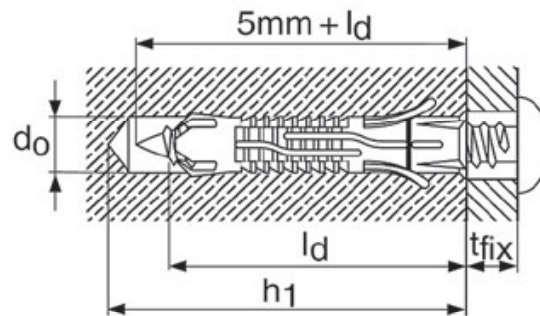

Setting details HUD-1

Anchor version			5x25	6x30	8x40	10x50	12x60	14x70
Nominal diameter of drill bit	d_0	[mm]	5	6	8	10	12	14
Cutting diameter of drill bit	$d_{cut} \leq$	[mm]	5,35	6,4	8,45	10,45	12,5	14,5
Depth of drill hole	$h_1 \geq$	[mm]	35	40	55	65	80	90
Effective anchorage depth	h_{nom}	[mm]	25	30	40	50	60	70
Anchor length	l	[mm]	25	30	40	50	60	70
Max fixture thickness	t_{fix}	[mm]	Depending on screw length					
Installation temperature		[°C]	-10 to +40					
Woodscrew diameter ^{a)}	d	[mm]	3,5 - 4	4,5 - 5	5 - 6	7 - 8	8 - 10	10 - 12

a) The basic loading data are depending on the woodscrew diameters, if other types or different screws are used the load capacity may decrease. Highlighted diameters refer to basic loading data table, except footnotes ^{a),b),c)} of basic loading data tables.