

# ΔΗΛΩΣΗ ΕΠΙΔΟΣΕΩΝ

σύμφωνα με το Παράρτημα III του Κανονισμού (ΕΕ) Αρ. 305/2011 (Κανονισμός Προϊόντων Δομικών Κατασκευών)

## Πυράντοχος επίδεσμος Hilti CFS-B

Αρ. Hilti CFS-B

**1. Μοναδικός κωδικός ταυτοποίησης του τύπου του προϊόντος:**

Πυράντοχος επίδεσμος Hilti CFS-B

**2. Προβλεπόμενη(-ες) χρήση(-εις):**

Προϊόν πυροφραγής και σφράγισης για σφραγίσματα περασμάτων, βλέπε ETA-20/0993 (28.12.2020)

Περάσματα σωλήνων	Μεταλλικοί σωλήνες με εύφλεκτη μόνωση
	Πλαστικοί σωλήνες με εύφλεκτη μόνωση
	Σωλήνες Σύνθετου Αλουμινίου με εύφλεκτη μόνωση

**3. Κατασκευαστής:**

Hilti Corporation, Feldkircherstrasse 100, 9494 Schaan, Principality of Liechtenstein

**4. Σύστημα AVCP (αξιολόγηση και επαλήθευση της σταθερότητας της επίδοσης):**

Σύστημα 1

**5. Ευρωπαϊκό έγγραφο αξιολόγησης:**

EAD 350454-00-1104

**Ευρωπαϊκή Τεχνική Αξιολόγηση:**

ETA-20/0993 (28.12.2020)

**Οργανισμός τεχνικής αξιολόγησης:**

OIB

**Κοινοποιημένος(-οι) οργανισμός(-οι):**

MPA-Braunschweig, Αρ. 0761

**6. Δηλωθείσα(-ες) επίδοση(-εις):**

Ουσιώδες χαρακτηριστικό	Δηλωθείσα επίδοση / Εναρμονισμένη τεχνική προδιαγραφή
Αντίδραση σε φωτιά	Κλάση E σύμφωνα με το EN 13501-1
Αντοχή σε φωτιά	Επίδοση αντοχής στη φωτιά και πεδίο εφαρμογής σύμφωνα με το EN 13501-2. Βλέπε Παράρτημα
Ανθεκτικότητα και λειτουργικότητα	Z <sub>2</sub> , σύμφωνα με την EAD 350454-00-1104, EOTA Technical Report - TR024
Άλλο	Δεν εφαρμόζεται / Δεν προσδιορίζεται επίδοση

Η επίδοση του προϊόντος που ταυτοποιείται ανωτέρω είναι σύμφωνη με τη (τις) δηλωθείσα(-ες) επίδοση(-εις). Η δήλωση αυτή των επιδόσεων συντάσσεται, σύμφωνα με τον κανονισμό (ΕΕ) αριθ. 305/2011, με αποκλειστική ευθύνη του κατασκευαστή που ταυτοποιείται ανωτέρω.

Υπογραφή για λογαριασμό και εκ μέρους του κατασκευαστή από:

Dorothy Wai  
Υπεύθυνος Προϊόντος  
Επιχειρησιακή Μονάδα Πυροπροστασίας  
Hilti Corporation

Martin Althof  
Επικεφαλής Ποιότητας  
Επιχειρησιακή Μονάδα  
Πυροπροστασίας  
Hilti Corporation

Schaan, 28.12.2020

## Intended use

### ANNEX C

#### RESISTANCE TO FIRE CLASSIFICATION OF PENETRATION SEALS MADE OF "HILTI FIRESTOP BANDAGE CFS-B"

Intended use of pipes and reference to relevant section.

Application	Pipe Material	Flexible and rigid wall	Rigid wall	Floor
		≥ 100 mm	≥ 200 mm	≥ 150mm
Heating	Copper	see C.2.1.2	see C.2.2.2	see C.2.3.2
	Steel	see C.2.1.3	see C.2.2.3	see C.2.3.3
	Alu Composite Pipes	see C.2.1.4	see C.2.2.4	see C.2.3.4
	Plastic Pipes	see C.2.1.5	-	see C.2.3.5
Potable Water	Stainless Steel	see C.2.1.3	see C.2.2.3	see C.2.3.3
	Alu Composite Pipes	see C.2.1.4	see C.2.2.4	see C.2.3.4
	Plastic Pipes	see C.2.1.5	-	see C.2.3.5
Cooling	Copper	see C.2.1.2	see C.2.2.2	see C.2.3.2
	Steel / Stainless Steel	see C.2.1.3	see C.2.2.3	see C.2.3.3
	Alu Composite Pipes	see C.2.1.4	see C.2.2.4	see C.2.3.4
	Plastic Pipes	see C.2.1.5		see C.2.3.5
Various	Copper	see C.2.1.2	see C.2.2.2	see C.2.3.2
	Steel	see C.2.1.3	see C.2.2.3	see C.2.3.3
	Alu Composite Pipes	see C.2.1.4	see C.2.2.4	see C.2.3.4
	Plastic Pipes	see C.2.1.5		see C.2.3.5

## C.1 General Information “Hilti Firestop Bandage CFS-B”

### C.1.1 Penetration seal and bandage installation

Pipes insulated with elastomeric combustible insulation (see Annex D) fire-stopped by wrapping the Hilti Firestop Bandage CFS-B twice around the insulation material.

Steel wire is utilised to hold the Hilti Firestop Bandage CFS-B together, positioned approximately in the first quarter measured from the flank.

The Hilti Firestop Bandage CFS-B is mounted on both sides of the penetration.

The Hilti Firestop Bandage CFS-B is then pushed into the penetration in line with the designated marking shown on center of the Hilti Firestop Bandage CFS-B. In case of 100 mm thick walls the Hilti Firestop Bandage CFS-B was placed 50 mm inside and 75 mm outside the flexible wall.

#### C.1.1.1 Single penetration seal

**Single insulated pipes running through the penetration are sealed utilising two layers of Hilti Firestop Bandage CFS-B.**

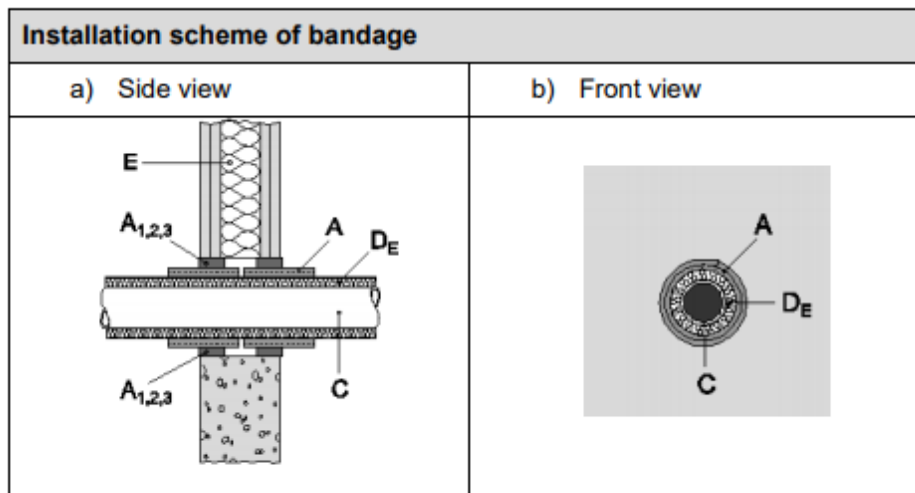

### C.1.1.2 Bundled Penetration

Small aluminium composite pipes ( $\leq \text{Ø } 16 \text{ mm}$ ) can be wrapped together in a double penetration with the Hilti Firestop Bandage CFS-B.

Hilti Firestop Bandage CFS-B is wrapped over both insulated pipes. Fixing and positioning of the bandage is as described above.

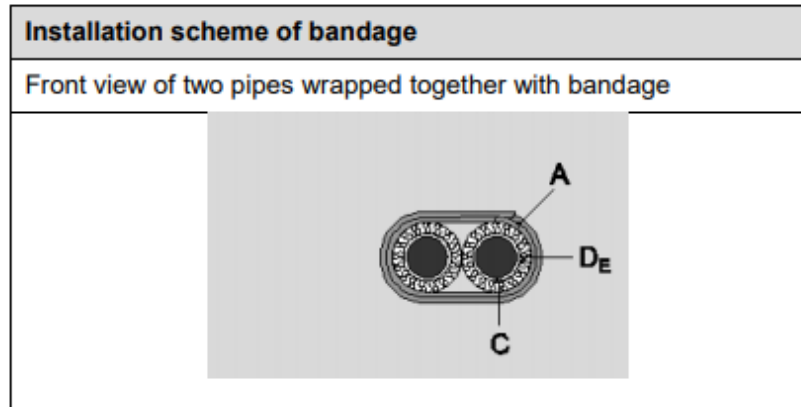

### C.1.2 Pipe insulation with combustible and mineral wool insulation

Specific insulation thickness with corresponding classification class is shown at each section below.

#### C.1.2.1 Elastomeric combustible insulation

Pipes insulated with elastomeric butyl rubber based insulation material are varying in thickness from 7,7 mm up to 45 mm in configuration (CS) Continued Sustained. See also table of butyl rubber based insulation at Annex D.

Thicknesses display generally measured values and correspond to nominal values with tolerances.

Results were displayed considering EN 1366-3:2009, clause E.2.7.5.2 and E.2.7.8.2 allowing interpolation of wall thickness and diameter between tested specimens and insulation thickness, respectively.

Metallic pipes from diameter 323,9 mm on were insulated by a fixed thickness of 25 mm elastomeric butyl rubber based insulation.

Metallic pipes were tested in C/U configuration, plastic and aluminum composite pipes in U/C configuration.

#### C.1.2.2 Glass-fiber mineral wool insulation

Instead of elastomeric butyl rubber based insulation glass-fiber mineral wool insulation (MW EN 14303-T4-ST(+)-260-MV2, e.G. Isover ML-3) could be used for direct insulation of copper and steel pipes. Specific application please see corresponding chapters.

#### C.1.2.3 Mineral wool insulation

Insulation of mineral wool (melting point  $> 1000^{\circ}\text{C}$ ) has a density of at least  $45 \text{ kg/m}^3$  (e.g. Rockwool Klimarock, RS 800). Insulation thickness depends on pipe diameter. Local Interrupted (LI).

### C.1.3 Additional protection

Additional insulation material (AP) is utilised for some applications and comprises of the following:

**AP1:** Armaflex AF elastomeric material for thermal insulation, 19 mm thick and 300 mm in length (LI) Local Interrupted

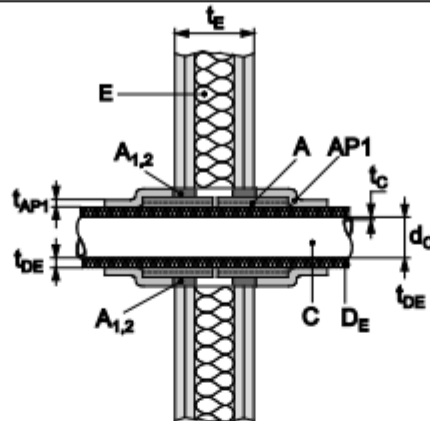

**AP2:** Mineral wool, Rockwool Klimarock, 40 mm thick, 250 mm in length; density approximately 45 kg/m<sup>3</sup> (LI) Local Interrupted

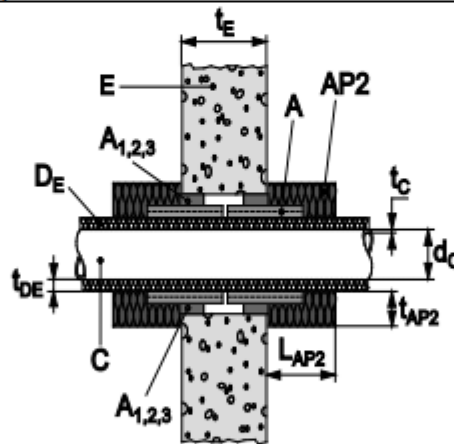

**AP3:** Beading / Outside Framing

Beading for flexible wall (100 mm) is applied by adding boards on both sides in two layers (2x12,5 mm Type F board) fixed with drywall screws. The resulting strips around the pipe whole are at least 50 mm in width (WB). Final penetration seal thickness is 150 mm.

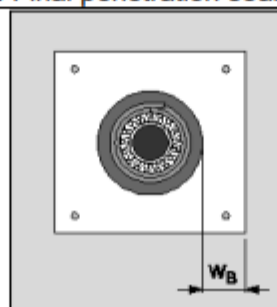

#### C.1.4 Distance to insulated pipes and other fire-stopped services

Distance of services to each other – references see below C.1.4.1 to C.1.4.5  
These distances are valid for flexible, rigid wall and floor

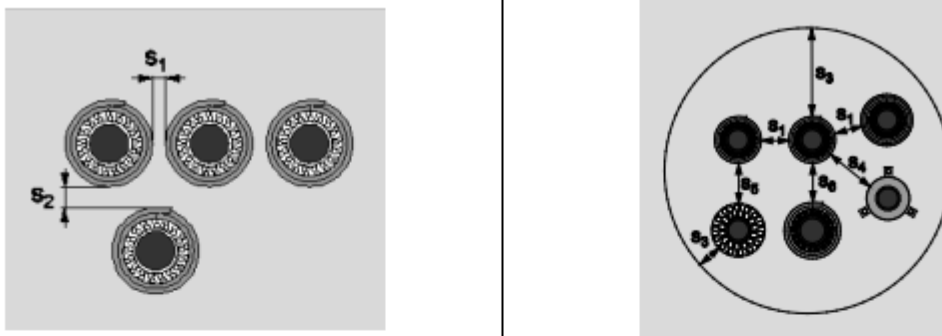

Sketches refer to round-shaped openings and their typical annular space

##### C.1.4.1 Distance to pipes firestopped by bandage in linear configuraton - S1

Distance is  $\geq 0$  mm to each other for insulated pipes wrapped by bandage CFS-B and in some cases to additional protection according classification.

##### C.1.4.2 Distance to pipes firestopped by bandage in cluster configuraton - S2

Distance is  $\geq 0$  mm to each other for insulated pipes wrapped by bandage CFS-B and in some cases to additional protection according classification.

##### C.1.4.3 Distances to seal edge - S3

In round openings distance to seal edge are up to 40mm. In case where no gap is left between construction and bandage, smoke tightness has to be secured.

##### C.1.4.4 Distance to Hilti Firestop Collar CFS-C EL - S4

Distance to Hilti Firestop Collar is shown to be zero. Please refer for detailed results the corresponding ETA 14/0085.

##### C.1.4.5 Distance to Mineral Wool Insulation - S5

Insulated pipes fire-stopped with Hilti Firestop Bandage CFS-B are tested to have a distance of zero to adjacent mineral wool ( $\geq 1000$  C°, 45 kg/m<sup>3</sup>) insulated penetrations (see C1.2.3) or respectively to additional protection.

##### C.1.4.6 Distance to PE-HD / PE-Xa and PP-R pipes- S6

Distance is  $\geq 0$  mm to each other for insulated pipes wrapped by bandage CFS-B and in some cases to additional protection according classification.

#### C.1.5 Annular Gap

In flexible and rigid wall Hilti Acrylic Firestop CFS-S ACR and gypsum is used to fill annular space. Mortar and gypsum is used in rigid walls and floors in full depth.

Hilti Acrylic Firestop CFS-S ACR is applied for gaps from 0 mm -15 mm at about 25 mm in depth.

Mortar and gypsum is used in rigid walls and floors, annular space is allowed from approximately 3 up to 40 mm.

#### C1.6 Pipe Support

Pipes are supported in wall application at a distance of 400 mm.

In floors first support was in 400 mm distance installed from surface.

## C.2 Testing of fire resistance in different constructions

### C.2.1 Flexible and rigid walls ( $\geq 100$ mm)

#### C.2.1.1 Setup of walls

Installation variations of insulated pipes protected by Hilti Firestop Bandage CFS-B

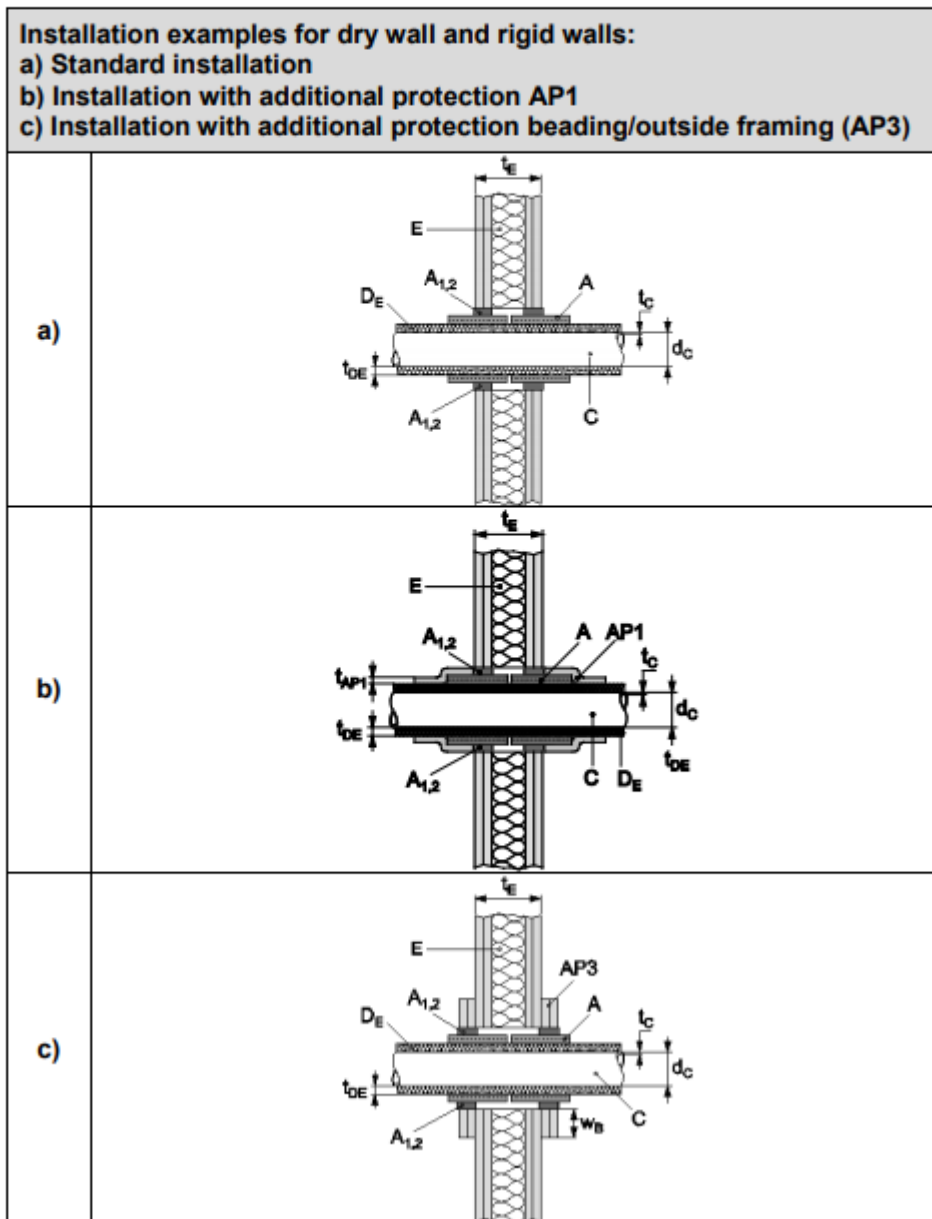

### C.2.1.2 Copper pipes

The field of application given is also valid for other metal pipes with lower heat conductivity than copper (approx. 350 W/mK at 20°C) and a melting point of minimum 1050°C.

#### C.2.1.2.1 Copper pipes are insulated with elastomeric butyl rubber based insulation ranging in thickness [mm] from 7,5mm till up to 36,5mm.

Service	Pipe diameter $d_c$ [mm]	Pipe wall thickness $t_c$ [mm]	Insulation thickness $t_{DE}$ [mm]		Classification C/U		
			from	to	addition. protection		
					-	AP 1	AP 3
Copper	10 to 18	1 - 14,2	7,5	32,0	EI 90	-	-
Copper	18 to 42	1 - 14,2	8,0	36,5	EI 60	EI 90	-
Copper	18 to 42	1 - 14,2	14,0	36,5	EI 90		-
Copper	18 to 42	1 - 14,2	8,0	36,5			EI 90
Copper	10 to 35	1 - 14,2	7,5	35,0			EI 120
<sup>1a,2</sup> Copper	10 to 54	1 - 14,2	30	30	EI 90		
<sup>1a,1,2</sup> Copper	28 to 88,9	1/2 - 14,2	10/30	100		EI 90	
<sup>2</sup> Copper	88,9	2 - 14,2	100	100		EI 120	

<sup>1a</sup> zero separation of pipes from 30 mm insulation on to each other and 100mm to other services

<sup>1</sup> separation of pipes to each other or other services 100 mm

<sup>2</sup> alternative glass fiber wool insulation according Annex C.1.2.2

**Copper pipe – relation wall thickness towards pipe diameter**  
Graph shows pipe wall thickness (II) towards pipe diameter ( $\varnothing d_c$ )

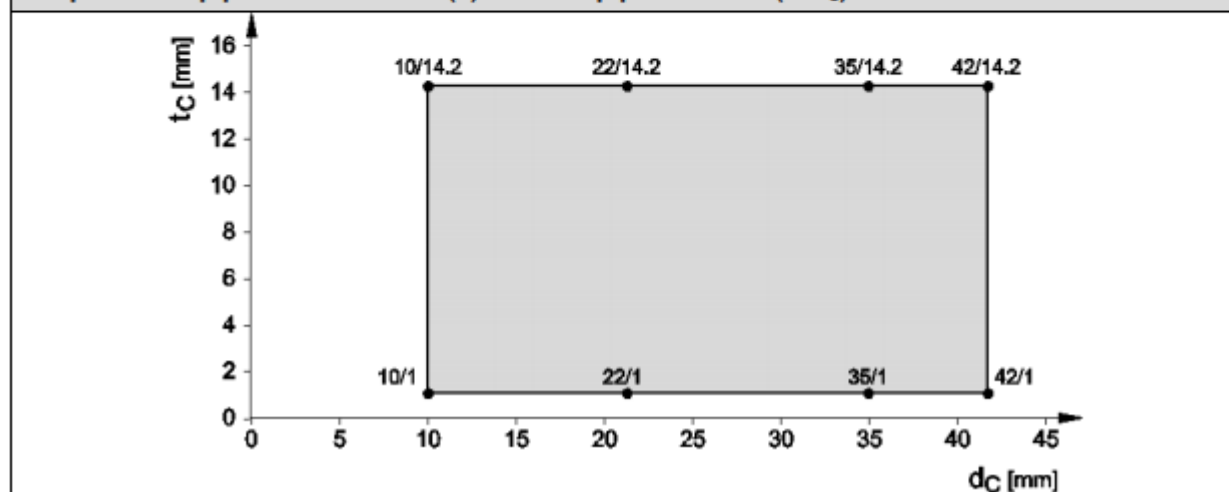



Copper pipes, wall ( $\geq 100$  mm) – EI 90, C/U (plus AP1 or AP3)  
 Thin insulation thickness acquires at higher pipe diameter additional protection (AP1 or AP3; dark area)  
 Graph shows assessed insulation thickness ( $t_{DE}$ ) at certain pipe diameter ( $\varnothing d_C$ )

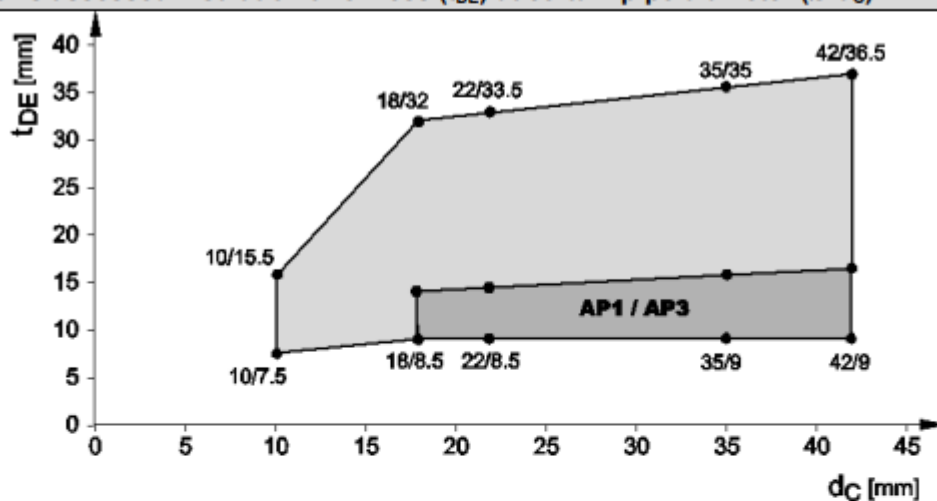

Copper pipes, wall ( $\geq 100$  mm) – EI 120, C/U plus AP3  
 Additional protection AP3 – penetration seal thickness 150 mm  
 Graph shows assessed insulation thickness ( $t_{DE}$ ) at certain pipe diameter ( $\varnothing d_C$ )

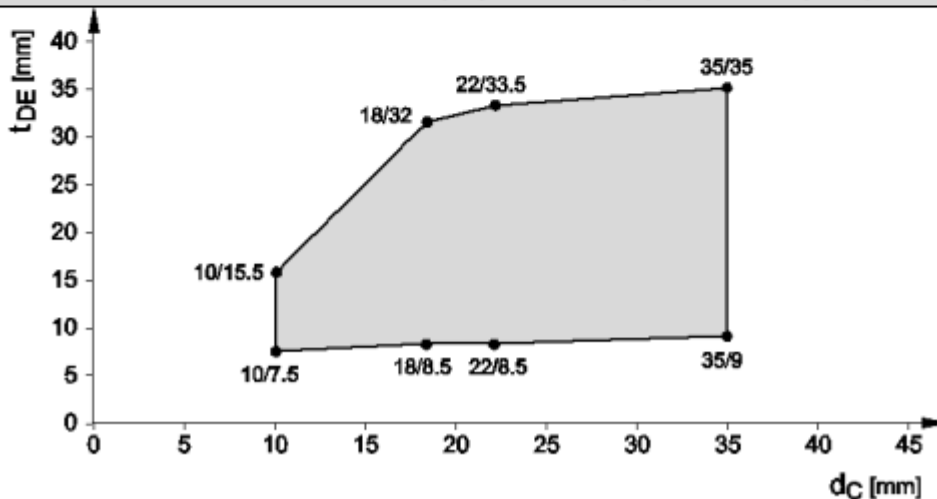

**Copper pipes ( $\varnothing$  28- 88,9), wall ( $\geq$  100 mm) – EI 90 C/U**  
**Butyl rubber based flexible foam insulation or glass-fiber mineralwool insulation according Annex C.1.2.2**  
**Graph shows assessed insulation thickness ( $t_{DE}$ ) at certain pipe diameter ( $\varnothing d_C$ )**

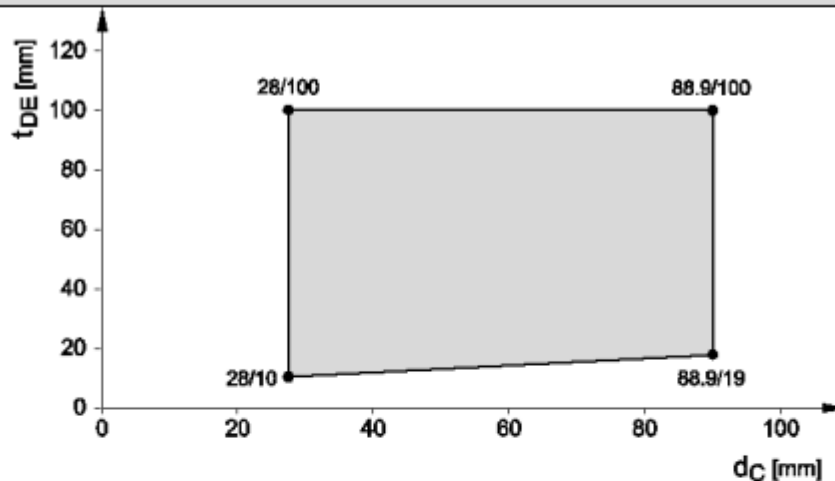

#### C.2.1.2.2 Copper pipes with preinstalled Wicu Flex PE Insulation

Copper pipes are pre-insulated with PE insulation (CS) ranging in thickness [mm] from 12 mm up to 22 mm.

Copper Service	Pipe diameter $d_C$ [mm]	Pipe wall thickness $t_C$ [mm]	Insulation thickness $t_{DE}$ [mm]		Classification C/U	
			from	to	-	AP 3
PE Insulation Wicu flex	12 to 22	1,0/1,5 to 14,2	6	6	EI 60	EI 120-

#### C.2.1.2.3 Copper pipes with PUR insulation

Copper pipes are insulated with PUR insulation of density 39,4 kg/m<sup>3</sup> ranging in thickness [mm] from 12 mm up to 54 mm (CS).

Copper Service	Pipe diameter $d_C$ [mm]	Pipe wall thickness $t_C$ [mm]	Insulation thickness $t_{DE}$ [mm]		Classification C/U	
			from	to	-	AP 3
PUR Insulation	12 to 54	1,0/1,5 to 14,2	10	50	EI 60	EI 90-

### C.2.1.3 Steel Pipes

Applying Annex E1.3.2 of DIN EN 1366-3:2009 the field of application given above for copper pipes is also valid for other metal pipes with lower heat conductivity than copper and a melting point of minimum 1050°C, e.g. unalloyed steel, low alloyed steel, cast iron, stainless steel, Ni alloys (NiCu, NiCr, NiMo alloys) and Ni.

Service	Pipe diameter $d_c$ [mm]	Pipe wall thickness $t_c$ [mm]	Insulation thickness $t_{DE}$ [mm]		Classification C/U		
			from	to	-	AP 1	AP 3
Steel	10,2 to 18	1 - 14,2	7,5	33,5	EI 90		
Steel	10,2 - 60	1 - 14,2	7,5	39			EI 120
Steel	18 to 42	1 - 14,2	8,5	36,5	EI 60	EI 90	
Steel	18 to 42	1 - 14,2	14,0	36,5	EI 90		
Steel	42,4 to 76	1,4 - 14,2	16,5	40,5	EI 90		
Steel	42,4 to 76	1,4 - 14,2	9,0	40,5		EI 90	
Steel	10,2 to 76	1 - 14,2	7,5	40,5		EI 90	
Steel	76 to 159	1,8/2,6 - 14,2	40,5	45	EI 120		
Steel <sup>1a,1,2</sup>	28 to 88,9	1/2 - 14,2	10/30	100		EI 90	
Steel <sup>1,2</sup>	88,9 to 114,3	2,0 - 14,2	40	40		EI 90	

<sup>1a</sup> zero separation of pipes from 30 mm insulation on to each other and 100mm to other services

<sup>1</sup> separation of pipes to each other or other services 100 mm

<sup>2</sup> alternative glass fiber wool insulation according Annex C.1.2.2

**Steel pipe, flexible wall ( $\geq 100$  mm) – relation wall thickness towards pipe diameter  
Graph shows pipe wall thickness ( $t_c$ ) towards pipe diameter ( $\varnothing d_c$ )**

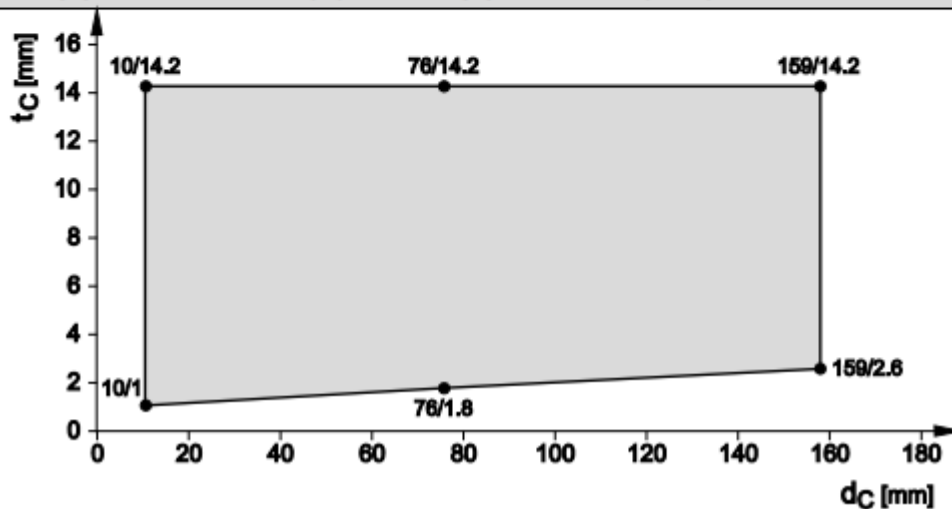

**Steel pipes, flexible wall ( $\geq 100$  mm) – EI 90 / EI 120 (dotted line) C/U**  
 Graph shows assessed insulation thickness ( $t_{DE}$ ) at certain pipe diameter ( $\varnothing d_C$ )

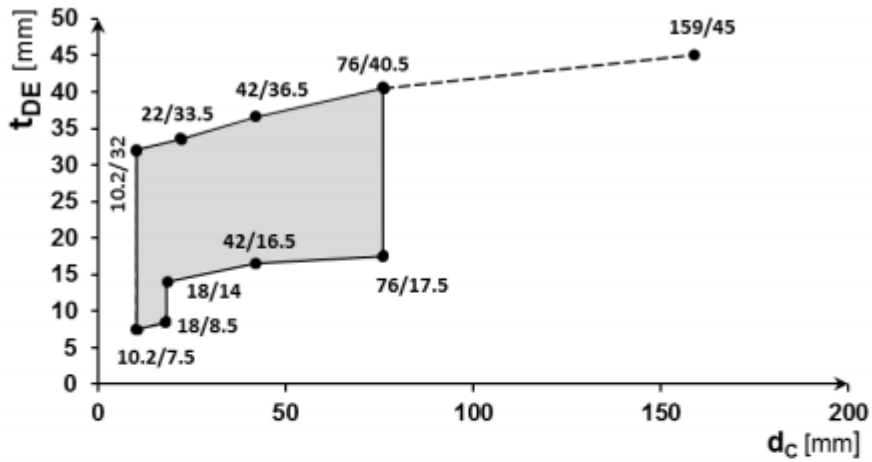

**Steel pipes, wall ( $\geq 100$  mm) – EI 90, C/U plus AP1**  
 Graph shows assessed insulation thickness ( $t_{DE}$ ) at certain pipe diameter ( $\varnothing d_C$ )

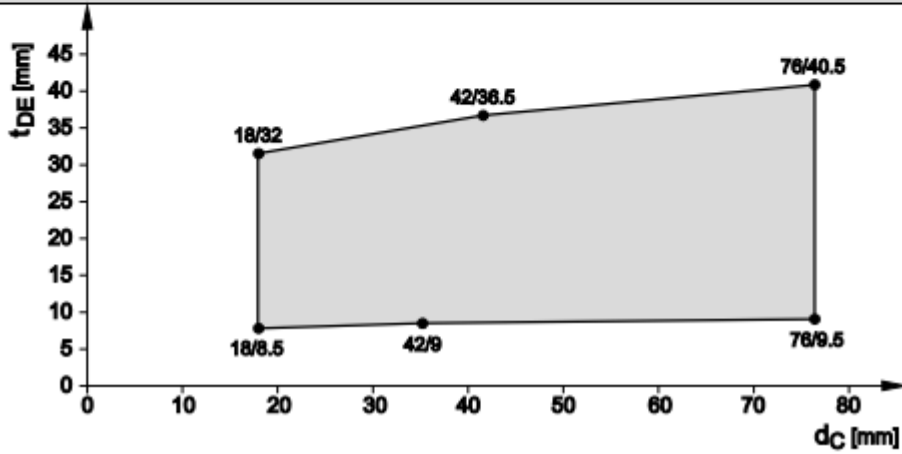

Steel pipes, wall ( $\geq 100$  mm) – EI 120, C/U plus beading (AP3)  
 Additional protection AP3, thickness of penetration seal 150 mm  
 Graph shows assessed insulation thickness ( $t_{DE}$ ) at certain pipe diameter ( $\varnothing d_C$ )

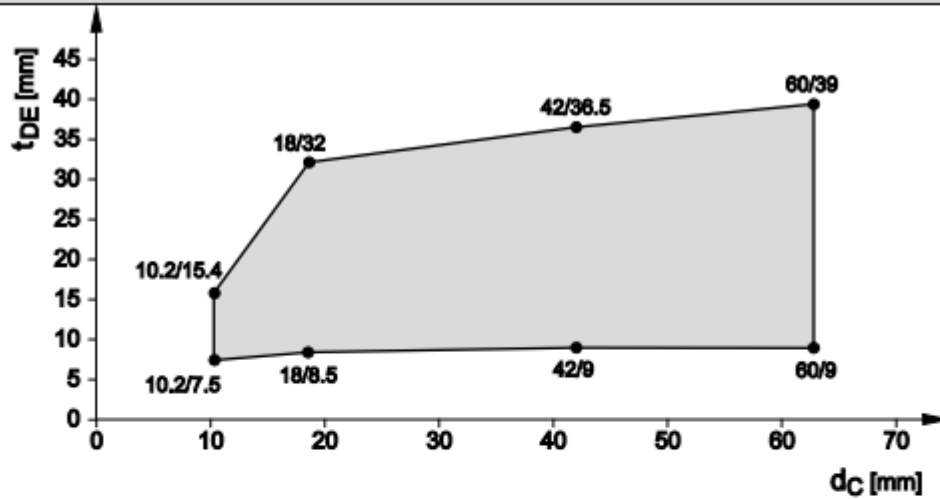

Steel pipes, walls ( $\geq 100$  mm) – EI 90 with AP1, C/U  
 Butyl rubber based flexible foam insulation or glass-fiber mineral wool insulation according Annex C.1.2.2  
 Graph shows assessed insulation thickness ( $t_{DE}$ ) at certain pipe diameter ( $\varnothing d_C$ )

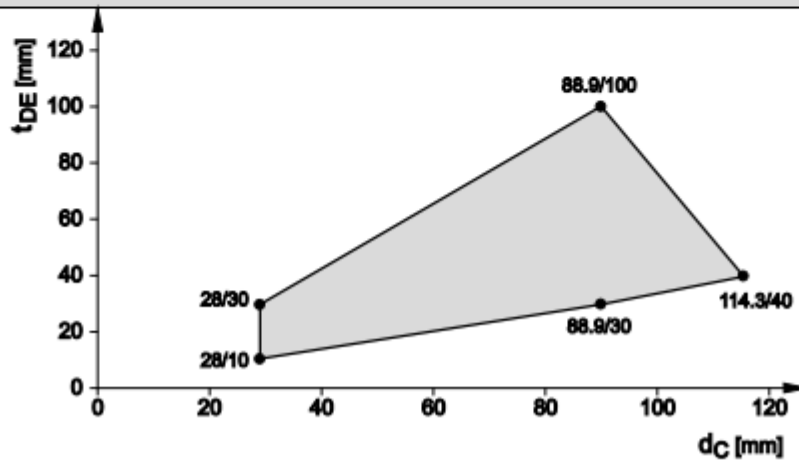

### C.2.1.4 Aluminum Composite Pipes

Aluminum composite pipes were available only at one pipe thickness for each diameter.

#### C.2.1.4.1 Aluminum Composite Pipes insulated with butyl rubber based flexible foam

Manufacturer	Product name	Pipe diameter dc (mm)	Insulation thickness (mm)		Classification U/C	
			From	To		AP3
Fränkische Rohrwerke	Alpex Profi F50	16 to 32	8,0	35,0	EI 90	
		32 to 40	9,0	36,5	EI 60	
		32 to 50	9,0	37,5		EI 120
		50 to 75	9,0	40,5	EI 60	
		50 to 75	37,5	40,5	EI 120	
Geberit*	Mepla	16 to 32	0	0	EI 90 <sup>2</sup>	
		16 to 32	8,0	35,0	EI 90	
		32 to 40	9,0	36,5	EI 60	
		32 to 50	9,0	37,5		EI 120
		50 to 75	9,0	40,5	EI 60	
		50 to 75	37,5	40,5	EI 120	
Georg Fischer	Sanipex	16 to 32	8,0	35,0	EI 90	
		32 to 40	9,0	36,5	EI 60	
		32 to 50	9,0	37,5		EI 120
		50 to 63	9,0	39,5	EI 60	
IVT	PRINETO Stabilrohr	17 to 52	8,0	37,5	EI 90	
		52 to 63	9,0	39,5	EI 60	
		17 to 63	32	39,5	EI 120	
KeKelit	KELOX KM 110	16 to 75	8,0	40,5	EI 90	
		16 to 75	32	40,5	EI 120	
Rehau	Rautitan stabil	16 to 40	8,0	36,5	EI 90	
		16 to 40	32,0	36,5	EI 120 <sup>1</sup>	
TECE	TECEflex Verbundrohr	16 to 50	8,0	37,5	EI 90	
		63	9,0	39,5	EI 60	
		16 to 63	32	40,5	EI 120	
Uponor	Unipipe plus	16 to 32	8,0	32,0	EI 120 <sup>1</sup>	
	Unipipe MLC	40 to 63	9,0	39,5		EI 90 <sup>2</sup>
Viega	SANIFIX Fosta-Rohr	16 to 32	8,0	33,0	EI 120 <sup>1</sup>	
		32 to 63	9,0	39,5	EI 60	
		32 to 50	9,0	37,5		EI 120
		16 to 63	32	39,5	EI 120	
	Raxofix	16 to 40	8,0	35,0	EI 120 <sup>1</sup>	
		40 to 63	9,0	39,5	EI 60	EI 120

<sup>1</sup> EI 90 for zero distance, 400 mm first support

<sup>2</sup> first pipe support 250 mm, distance to next service 100 mm

Small pipes ( $\leq \varnothing 16$  mm) can be wrapped in a twin manner with bandage and perform EI 120

Graph shows results simplified, for all details see table above.

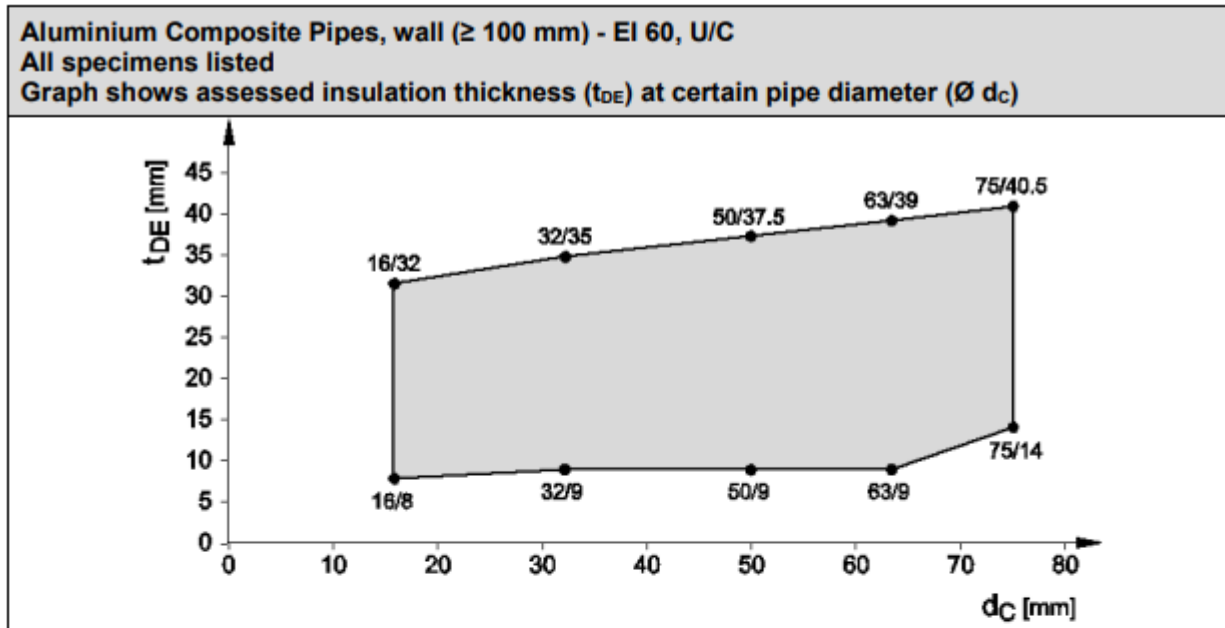

Group 1 of composite pipes (grey shaded) – Brand: Kekelit (Kelox), IVT (Prineto Stabil Rohr), Rehau ( $\leq 40$  mm; Rautitan stabil), TECEflex

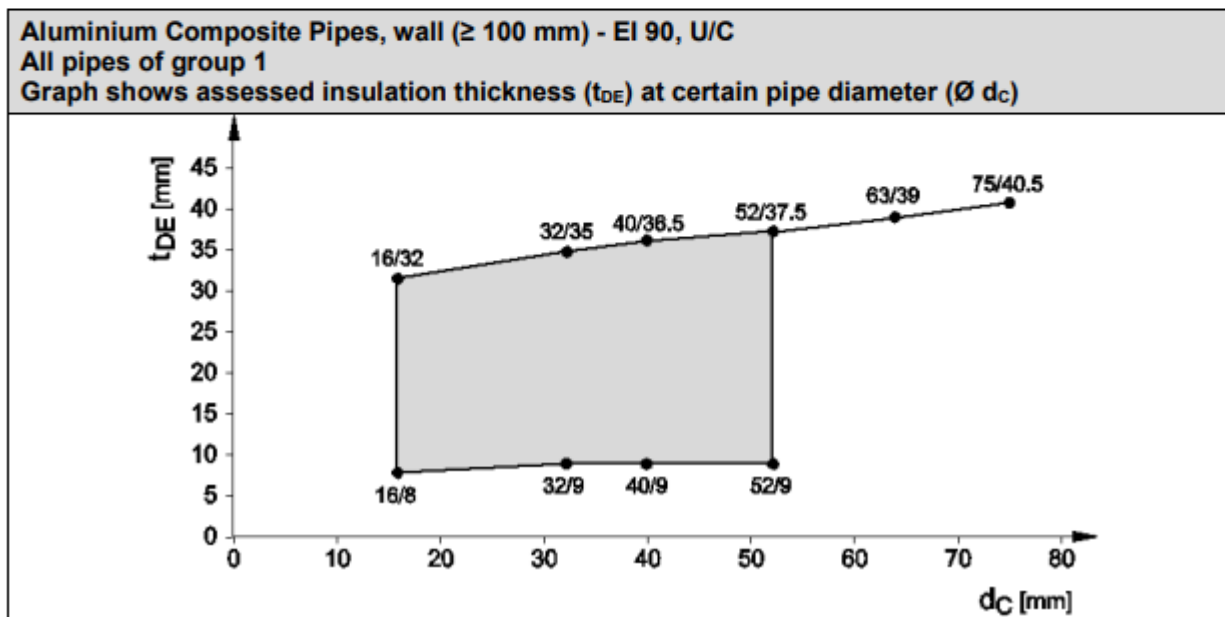

Group 2 of composite pipes - Brand: Fränkische Rohrwerke (Alpex System), Geberit (Mepia), Georg Fischer (Sanipex), Viega (Sanifix Fosta), Uponor (Unipipe Plus)

**Aluminium Composite Pipes, wall ( $\geq 100$  mm) - EI 90, U/C**

All pipes of group 2

Graph shows assessed insulation thickness ( $t_{DE}$ ) at certain pipe diameter ( $\varnothing d_C$ )

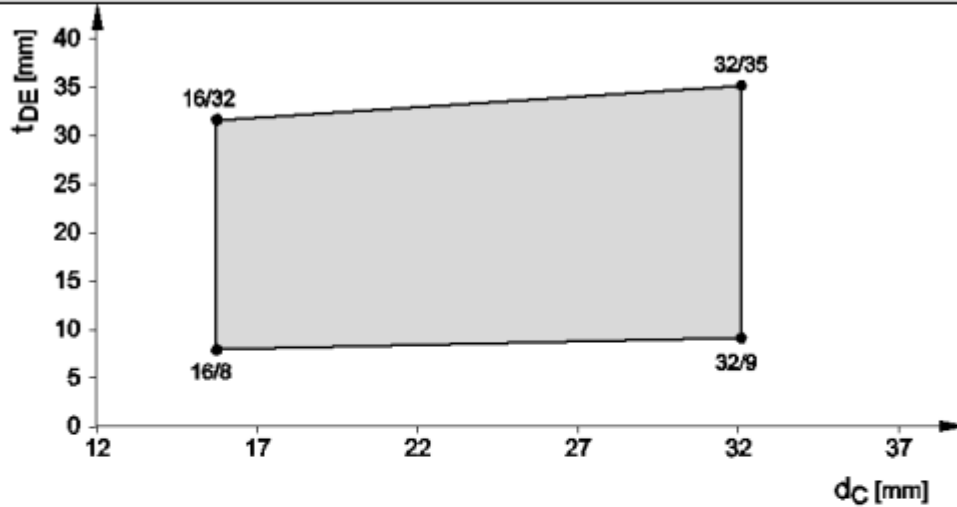

**Aluminium Composite Pipes, wall ( $\geq 100$  mm) - EI 120, U/C plus beading**

All pipes of group 2 \*

Graph shows assessed insulation thickness ( $t_{DE}$ ) at certain pipe diameter ( $\varnothing d_C$ )

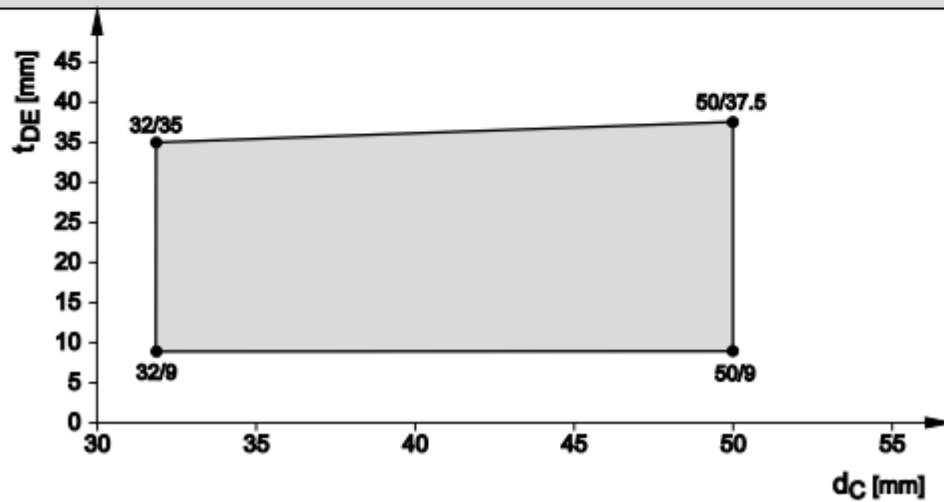

\* Uponor MLC - EI 90



**C.2.1.4.2 Aluminium Composite Pipes with protection pipe and or pre-insulated closed-cell PE foam**

Manufacturer	Product name	Pipe diameter $d_c$ (mm)	Insulation thickness (mm)		Classification U/C
			From	To	
Geberit	Mepia pre-insulated	16 to 26	6,0	13,0	EI 120
KeKelit Kelox <sup>1</sup>	Pro KM 130	14 to 32	9,0	9,0	EI 120
	Plus KM 134	14 to 32	4,0	9,0	EI 120
	Pro KM 140	16 to 20	PE HD	tube	EI 120
	Plus KM 144	16 to 20	4+ PE	HD tube	EI 120
Uponor <sup>1</sup>	Unipipe plus	16 to 25	4,0	10,0	EI 120
	Unipipe MLC	16 to 20	PE HD	tube	EI 120

<sup>1</sup> PE Foam has fire resistance classified according EN 13501-1 as E

**C.2.1.5 Plastic pipes**

**C.2.1.5.2 Plastic pipes made of PE-Xa (EN ISO 15875) and PE (EN 12201-2)**

Pipe insulation was butyl rubber based flexible foam.

Service	Pipe diameter $d_c$ [mm]	Pipe wall thickness $t_c$ [mm]	Insulation thickness $t_{DE}$ [mm]		Classification U/C
			from	to	
PE-Xa Rautitan Flex	16 to 63	2,2 to 8,6	8,0	39,0	EI 120
PE / XSC 50 Wavin TS PE 100	50 to 110	4,6 to 10	9,0	42,5	EI 120

Plastic pipes PE-X according EN ISO 15875, wall ( $\geq 100$  mm) - EI 120, U/C  
Graph shows assessed insulation thickness ( $t_{DE}$ ) at certain pipe diameter ( $\varnothing d_C$ )

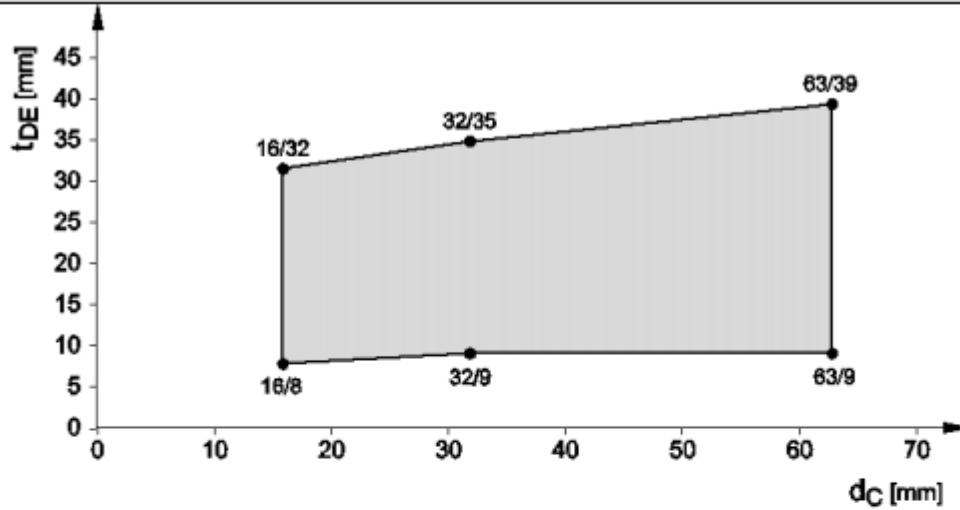

Plastic pipes PE-HD according EN 12201-2, wall ( $\geq 100$  mm) - EI 120, U/C  
Graph shows assessed insulation thickness ( $t_{DE}$ ) at certain pipe diameter ( $\varnothing d_C$ )

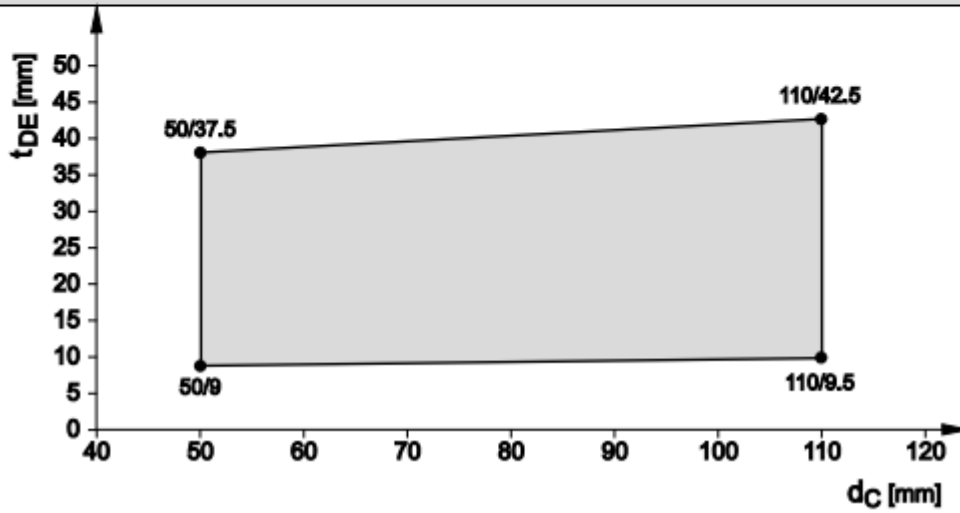

### C.2.1.5.2 Plastic pipes made of PP-R (EN 15874 / DIN 8077/78 / ISO 21003)

Plastic pipes are insulated with butyl rubber based flexible foam.

Manufacturer	Product name	Pipe diameter $d_c$ (mm)	Wall thickness (mm)	Insulation thickness (mm)		Classification U/C
				From	To	
Aquatarm	Green <sup>1,3</sup>	20 to 110	1,9 to 10	8,0	40,5	EI 120*
	Blue <sup>1,3</sup>	20 to 110	1,9 to 10	8,0	40,5	EI 120*
Poloplast	Polo-Polymutan ML5 <sup>2</sup>	20 to 75	2,8 to 10,3	8,5	40,5	EI 120*
	Polo-Polymutan <sup>3</sup>	20 to 75	1,9 to 6,8	8,0	40,5	EI 90
	Polo-Tersia <sup>3</sup>	20 to 75	1,9 to 12,5	8,0	40,5	EI 90
Kekelit Ketrax	Cryolen Polyolefinblend <sup>1</sup>	20 to 75	1,9 to 6,8	8,0	40,5	EI 90

\* for zero distance and / or 400 mm first pipe support classification is EI 90 U/C

<sup>1</sup> according EN 15874

<sup>2</sup> according ISO 21003

<sup>3</sup> according DIN 8077/78

## C.2.2 Rigid Wall ( $\geq 200$ mm)

### C.2.2.1 Set-up of rigid wall

The wall must have a minimum thickness of 200 mm and comprise of concrete, aerated concrete or masonry, with a minimum density of 550 kg/m<sup>3</sup>.

Installation variants of insulated pipes protected by Hilti Firestop Bandage CFS-B

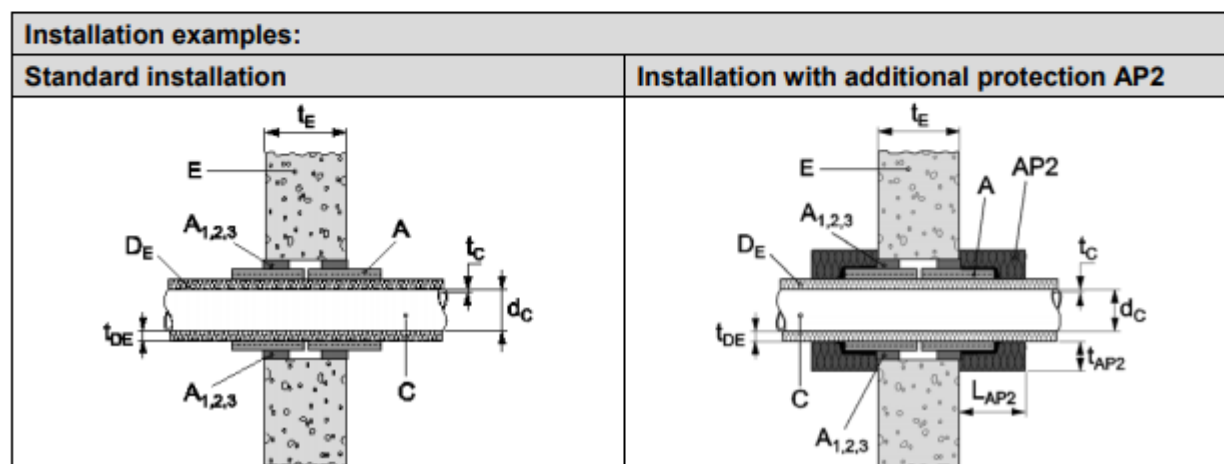

## C.2.2.2 Copper Pipes

### C.2.2.2.1 Copper Pipes with butyl rubber based insulation or glass wool insulation

Service	Pipe diameter $d_c$ [mm]	Pipe wall thickness $t_c$ [mm]	Insulation thickness $t_{DE}$ [mm]		Classification C/U
			from	to	
			$\varnothing$ small	$\varnothing$ big	-
Copper	10 to 42	1 - 14,2	7,5	36,5	EI 90
Copper	10 to 35	1 - 14,2	7,5	35,0	EI 120
<sup>1,2</sup> Copper	28 to 88,9	1/2 - 14,2	10/19	100	EI 90

<sup>1</sup> separation of pipes to each other or other services 100 mm

<sup>2</sup> alternative glass fiber wool insulation according Annex C.1.2.2

**Copper pipe, rigid wall ( $\geq 200$  mm) – relation wall thickness towards pipe diameter  
Graph shows pipe wall thickness ( $t_c$ ) towards pipe diameter ( $\varnothing d_c$ )**

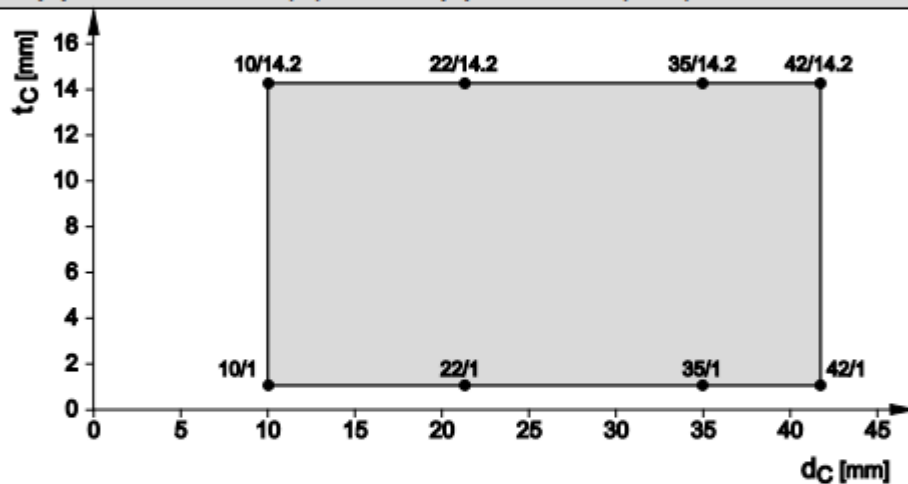

**Copper pipes, rigid wall ( $\geq 200$  mm) – EI 120 / EI 90, C/U  
Graph shows assessed insulation thickness ( $t_{DE}$ ) at certain pipe diameter ( $\varnothing d_c$ )**

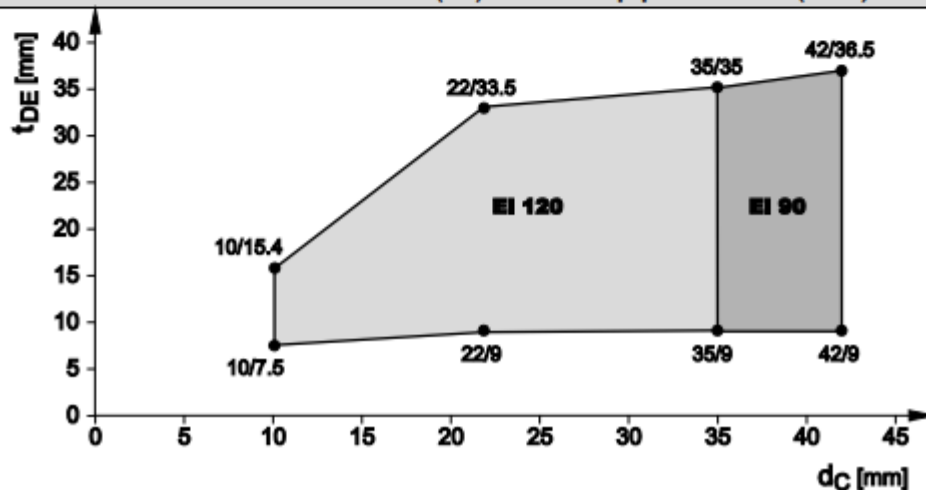

### C.2.2.3 Steel pipes

Applying Annex E1.3.2 of DIN EN 1366-3:2009 the field of application given in C.2.2.2 for copper pipes is also valid for other metal pipes with lower heat conductivity than copper and a melting point of minimum 1050°C, e.g. unalloyed steel, low alloyed steel, cast iron, stainless steel, Ni alloys (NiCu, NiCr, NiMo alloys) and Ni.

Service	Pipe diameter $d_c$ [mm]	Pipe wall thickness $t_c$ [mm]	Insulation thickness $t_{DE}$ [mm]		Classification C/U	
			from	to	-	AP 2
Steel	10,2 to 60	1 to 14,2	7,5	39	EI120	
Steel	76 to 159	1,8 to 14,2	17,5	45	EI 90	
Steel	159	2 to 14,2	16	45	EI 120	
Steel	159 to 813	2 to 14,2	25	25		EI 120
Steel <sup>1a,1,2</sup>	28 to 88,9	1/2 to 14,2	10/30	30	EI 90	
Steel <sup>1,2</sup>	88,9 to 159	2,0 to 14,2	40	80	EI 90	

<sup>1a</sup> EI 120; zero separation of pipes at 30 mm insulation on to each other and 100 mm to other services

<sup>1</sup> separation of pipes to each other or other services 100 mm

<sup>2</sup> alternative glass fiber wool insulation according Annex C.1.2.2

AP 2 insulation was applied in a length of 500 mm for pipe  $\varnothing$  813. Therefore, this is valid for pipe range from  $\varnothing$  159 to  $\varnothing$  813 mm.

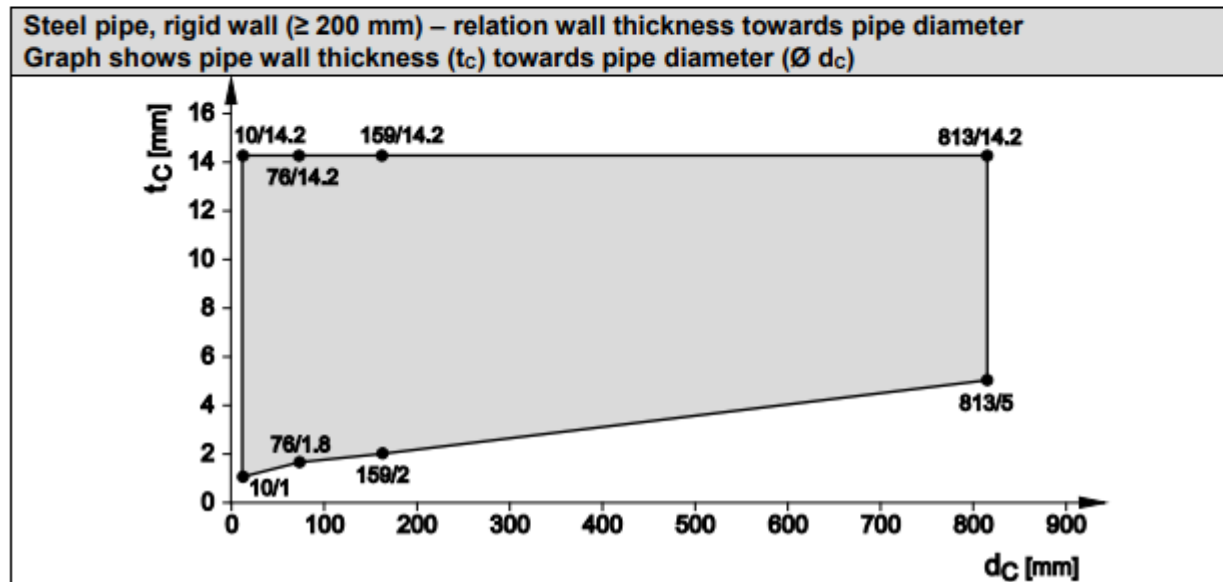

Steel pipes, C/U, rigid wall ( $\geq 200$  mm) – EI 120 /90, C/U  
 Graph shows assessed insulation thickness ( $t_{DE}$ ) at certain pipe diameter ( $\varnothing d_C$ )

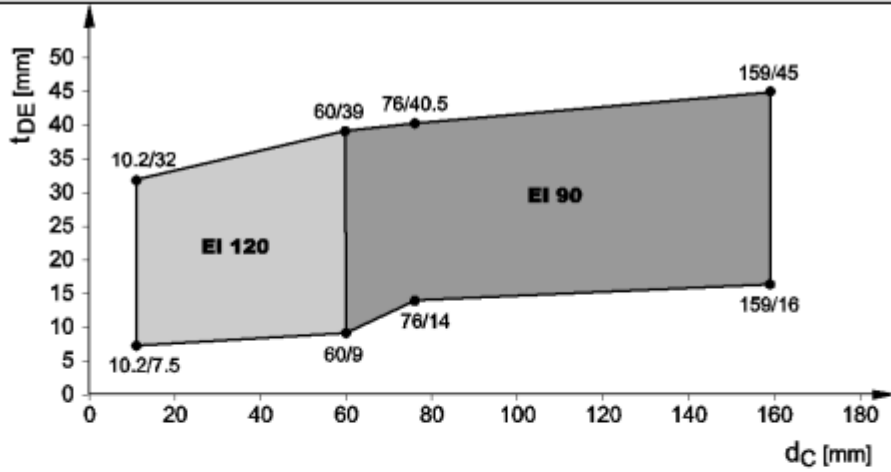

Steel pipes, rigid wall ( $\geq 200$  mm) – EI 120, C/U  
 Insulated large pipes from  $\varnothing 159$  up to 813 mm  
 Elastomeric insulation plus additional protection mineralwool (AP2, Klimarock 40 mm)  
 Graph shows assessed insulation thickness ( $t_{DE}$ ) at certain pipe diameter ( $\varnothing d_C$ )

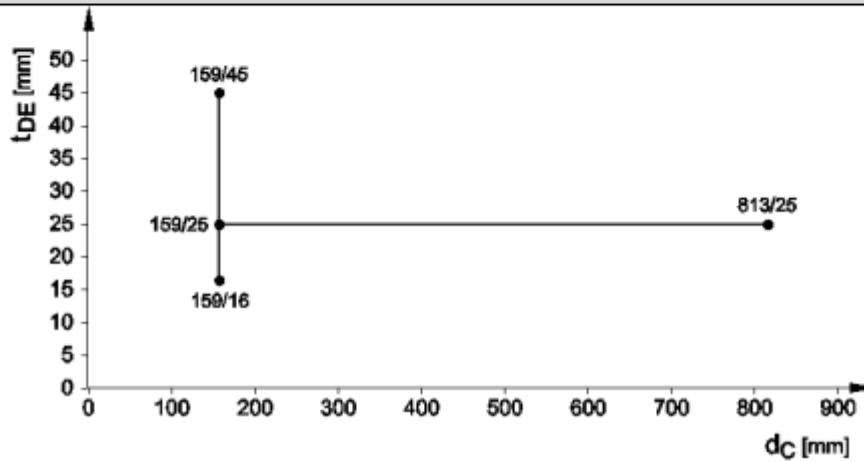

### C.2.2.4 Aluminium Composite Pipes

Aluminium composite pipes were available only at one pipe thickness for each diameter.

Manufacturer	Product name	Pipe diameter $d_c$ (mm)	Insulation thickness (mm)		Classification U/C
			from	to	
Fränkische Rohrwerke	Alpex F50 Profi	16 to 63	8,0	39,0	EI 120
Geberit	Mepla	16 to 63	8,0	39,0	EI 120
Georg Fischer	Sanipex	16 to 63	8,0	39,0	EI 120
IVT	PRINETO Stabilrohr	16 to 63	8,0	39,0	EI 120
KeKelit	KELOX KM 110	16 to 63	8,0	39,0	EI 120
Rehau	Rautitan stabil	16 to 63	8,0	39,0	EI 120
TECE	TECEflex Verbundrohr	16 to 63	8,0	39,0	EI 120
Viega	SANIFIX Fosta-Rohr	16 to 63	8,0	39,0	EI 120

Result is valid for composite pipes group 1 and 2 with exception Uponor (see C.2.1.4.1)

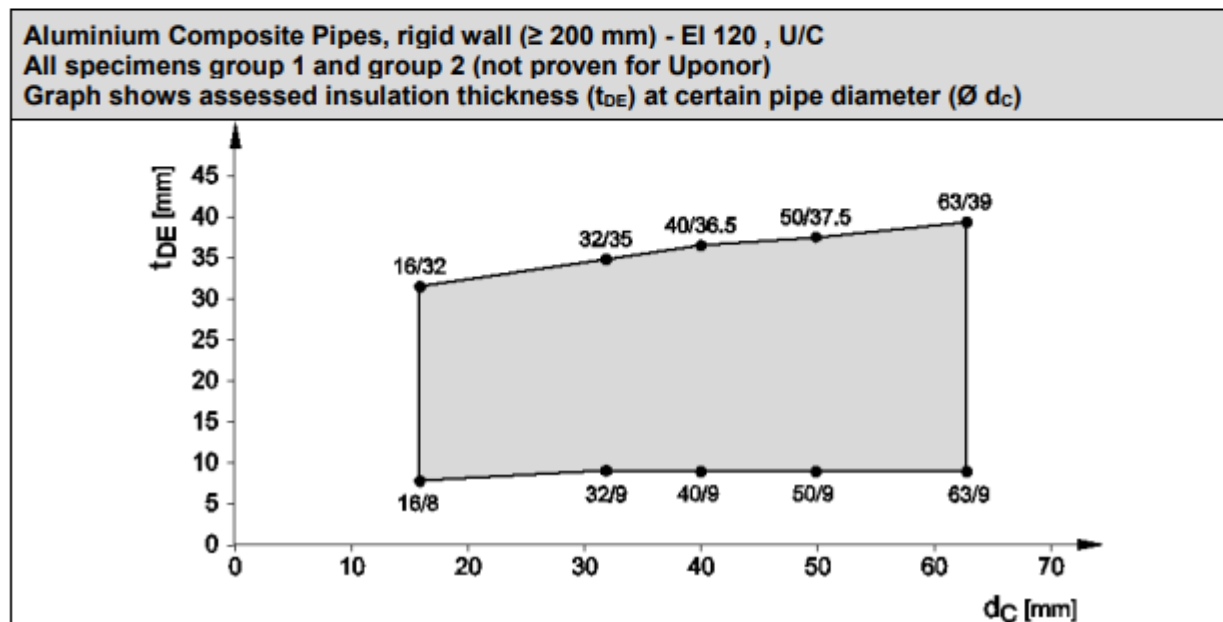

### C.2.3 Floor

#### C.2.3.1 Setup of floor ( $\geq 150$ mm)

The supporting construction is build according EN 1355-3:2009 of at least lightweight concrete slabs of a thickness of 150 mm and a density of 550 kg/m<sup>3</sup>.

Installation variants of insulated pipes protected by Hilti Firestop Bandage CFS-B.

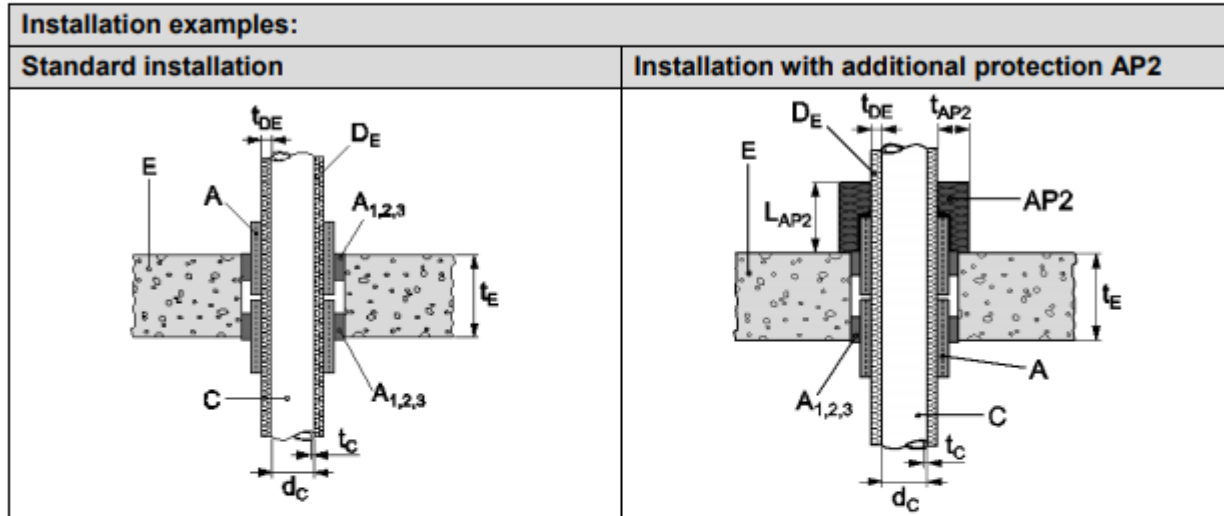

#### C.2.3.2 Copper Pipes

##### C.2.3.2.1 Copper Pipes with butyl rubber based flexible foam insulation

Service	Pipe diameter $d_c$ [mm]	Pipe wall thickness $t_c$ [mm]	Insulation thickness $t_{DE}$ [mm]		Classification C/U		
			from	to	-	AP 1	AP 2
Copper	10 to 35	1 - 14,2	7,5	35,0	EI 120	-	-
Copper	35 to 42	1 - 14,2	9,0	36,5	EI 60		EI 120
Copper	42	1,2	9,0	35	EI 120		
<sup>1,2</sup> Copper	28 to 88,9	1/2 - 14,2	10	100	EI 90		

<sup>1</sup> separation of pipes to each other or other services 100 mm

<sup>2</sup> alternative glass fiber wool insulation according Annex C.1.2.2



Copper pipe, rigid floor ( $\geq 150$  mm) – relation wall thickness towards pipe diameter  
 Graph shows pipe wall thickness ( $t_C$ ) towards pipe diameter ( $\varnothing d_C$ )

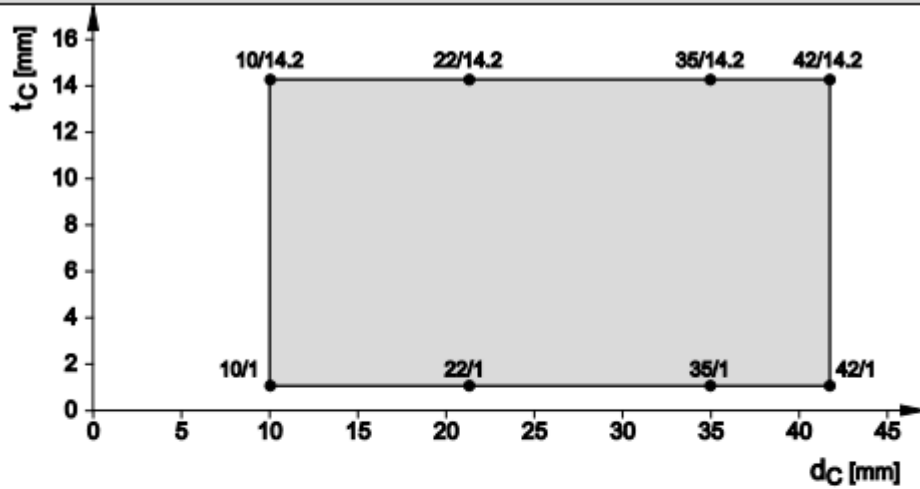

Copper pipes, floor ( $\geq 150$  mm) – EI 120 / EI 60 / EI 120 plus AP2, C/U  
 Additional protection AP2 (mineral wool) is required from  $\varnothing 35$  to  $\varnothing 42$  mm to reach EI 120  
 Graph shows assessed insulation thickness ( $t_{DE}$ ) at certain pipe diameter ( $\varnothing d_C$ )

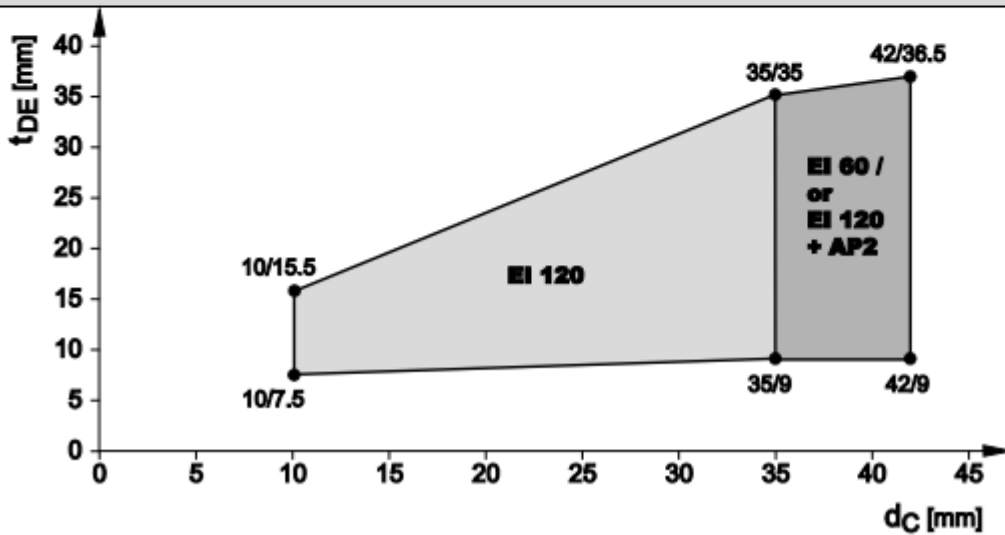

**Copper pipes ( $\varnothing$  28 - 88,9), floor ( $\geq 150$  mm) – EI 90 C/U**

**Butyl rubber based flexible foam insulation or glass-fiber mineralwool insulation according Annex C.1.2.2**

**Graph shows assessed insulation thickness ( $t_{DE}$ ) at certain pipe diameter ( $\varnothing d_C$ )**

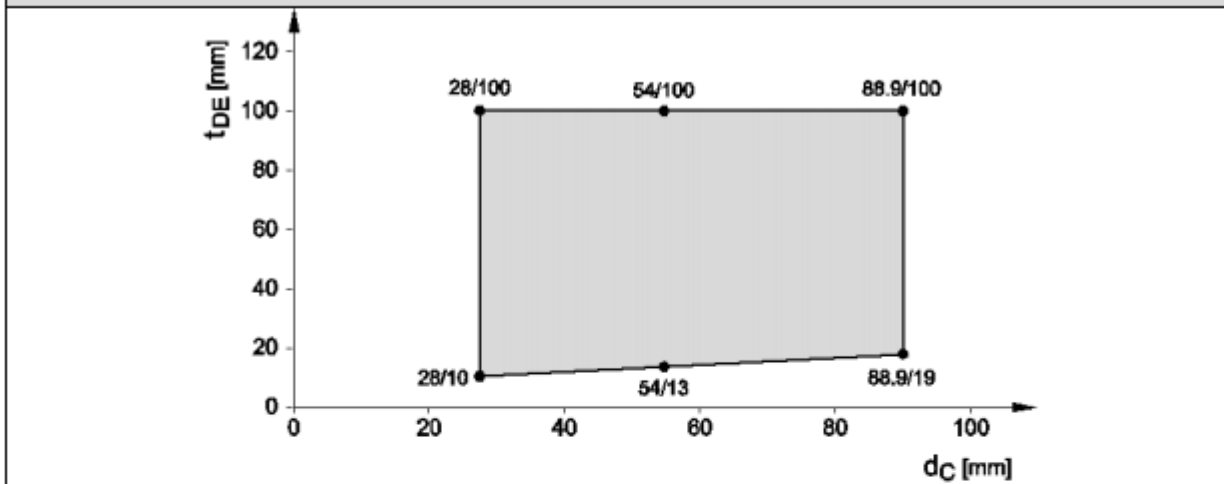

#### C.2.3.2.2 Copper pipes with preinstalled Wicu Flex PE Insulation

Copper pipes are pre-insulated with PE insulation (CS) ranging in thickness [mm] from 12 mm up to 22 mm.

Copper Service	Pipe diameter $d_C$ [mm]	Pipe wall thickness $t_C$ [mm]	Insulation thickness $t_{DE}$ [mm]		Classification C/U-
			from	to	
Wicuflex*	22	1,0 to 14,2	6,0	6,0	EI 180

\* distance to next penetration  $\geq 150$  mm; first pipe support  $\geq 250$  mm

#### C.2.3.2.3 Copper pipes with PUR insulation

Copper pipes are insulated with PUR insulation of density 39,4 kg/m<sup>3</sup> ranging in thickness [mm] from 12 mm up to 54 mm (CS).

Copper Service	Pipe diameter $d_C$ [mm]	Pipe wall thickness $t_C$ [mm]	Insulation thickness $t_{DE}$ [mm]		Classification C/U-
			from	to	
PUR insulation*	12 to 54	1,5 to 14,2	10,0	50,0	EI 120

\* distance to next penetration  $\geq 150$  mm; first pipe support  $\geq 250$  mm

### C.2.3.3 Steel Pipes

Service	Pipe diameter $d_c$ [mm]	Pipe wall thickness $t_c$ [mm]	Insulation thickness $t_{DE}$ [mm]		Classification C/U	
			from	to	-	AP 2
Steel	10,2 to 60	1 to 14,2	7,5	39,0	EI120	
Steel	60 to 76	1 to 14,2	9,0	40,5	EI 90	EI 120
Steel	76 to 108	1,8 to 14,2	14,0	42,5	EI 90	
Steel	10,2 to 114,3	1 to 14,2	15,5	42,5	EI 120	
Steel <sup>3</sup>	76 to 159	1,8 to 14,2	9,5	45		EI 120
Steel <sup>3</sup>	159 to 323,9	1,8 to 14,2	25	25		EI 120
Steel <sup>4</sup>	76 to 159	1,8 to 14,2	9,0	45	EI 60	
Steel <sup>1,2</sup>	88,9 to 159	2,0 to 14,2	25	80	EI 90	
Steel <sup>1,2,5</sup>	28 to 54	1/2 to 14,2	10	40	EI 90	

<sup>1</sup> separation of pipes to each other or other services 100 mm

<sup>2</sup> alternative glass fiber wool insulation according Annex C.1.2.2

<sup>3</sup> till  $\varnothing 159$  mm insulation thickness is up to 45 mm; pipe diameters above butyl rubber based insulation is 25 mm.

AP 2 – Klima Rock Insulation 40 mm at a length of 500 mm.

<sup>4</sup> minimal insulation thickness above  $\varnothing 114,3$  mm is increased to 16 mm

<sup>5</sup> with only one wrapping

**Steel pipe, floor ( $\geq 150$  mm) – relation wall thickness towards pipe diameter  
Graph shows pipe wall thickness ( $t_c$ ) towards pipe diameter ( $\varnothing d_c$ )**

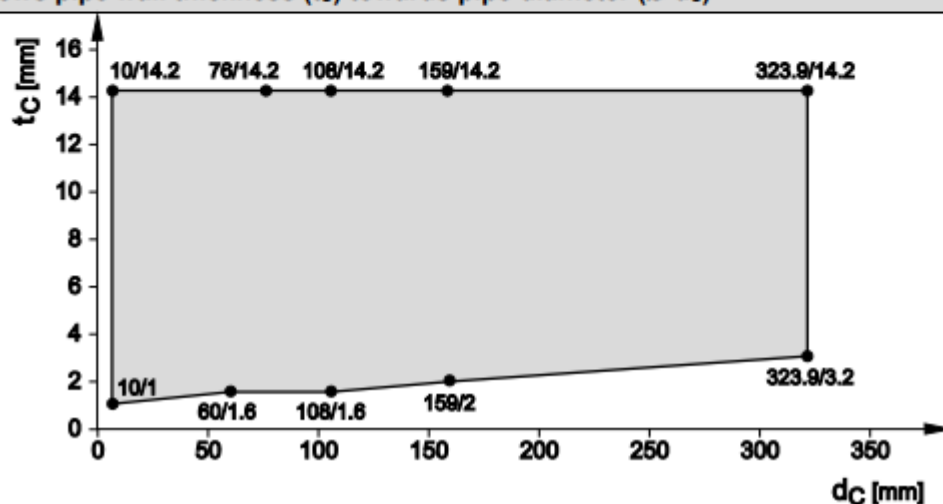

Steel pipes, floor ( $\geq 150$  mm) – EI 120 / EI 90 / EI 60, C/U

Different insulation thickness results in distinct classifications

EI 120 classification is valid for highest insulation thickness up to  $\varnothing$  114 mm (dotted line)

Graph shows assessed insulation thickness ( $t_{DE}$ ) at certain pipe diameter ( $\varnothing d_C$ )

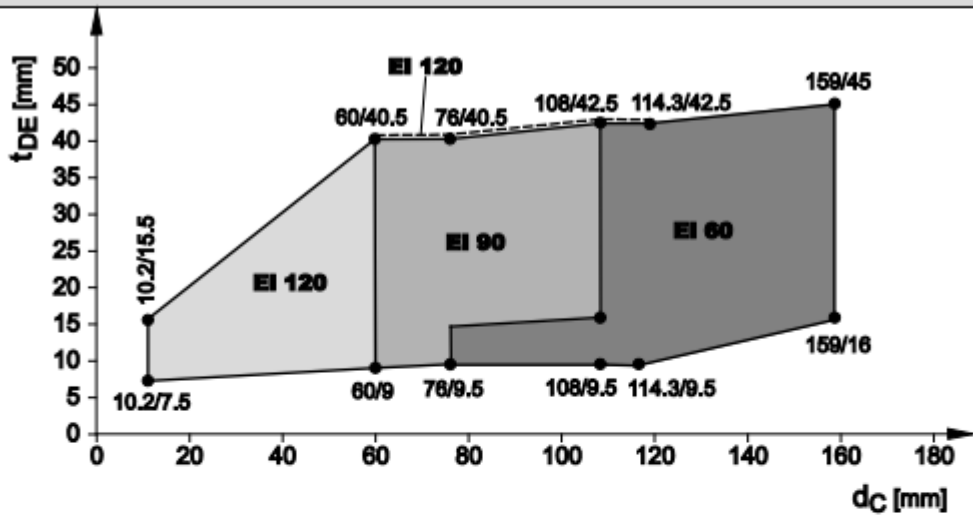

Steel pipes, floor ( $\geq 150$  mm) – EI 120, C/U plus AP2

Pipes insulated with elastic butyl rubber based insulation are additionally protected by AP2 (Klimarock 40 mm)

Graph shows assessed insulation thickness ( $t_{DE}$ ) at certain pipe diameter ( $\varnothing d_C$ )

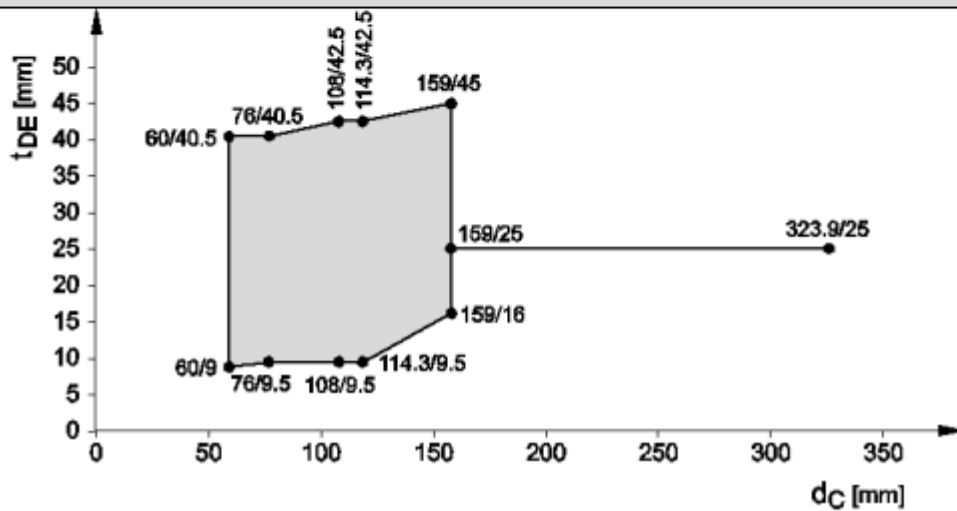

Steel pipes (Ø 28 - 88,9), floor (≥ 150 mm) – EI 90, C/U  
 Butyl rubber based flexible foam insulation or glass-fiber mineral wool insulation according  
 Annex C.1.2.2  
 Graph shows assessed insulation thickness ( $t_{DE}$ ) at certain pipe diameter (Ø  $d_c$ )

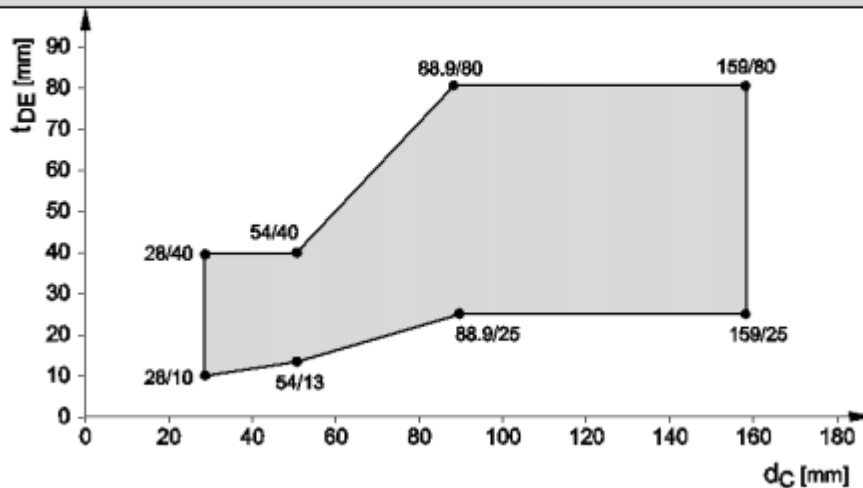

### C.2.3.4 Aluminium Composite Pipes

Aluminium composite pipes were available only at one pipe thickness for each diameter.

#### C.2.3.4.1 Aluminium Composite Pipes insulated with butyl rubber based flexible foam

Manufacturer	Product name	Pipe diameter $d_c$ (mm)	Insulation thickness (mm)		Classification U/C
			from	to	
Fränkische Rohrwerke	Alpex F50 Profi	16 to 40	8,0	36,5	EI 120
		40 to 75	9,0	40,5	EI 90
		75	40,5	40,5	EI 180
Geberit	Mepla	16 to 32	0	0	EI 240 <sup>1</sup>
		16 to 75	8,0	39,5	EI 120
		75	40,5	40,5	EI 180
Georg Fischer	Sanipex	16 to 63	8,0	39,5	EI 120
IVT	PRINETO Stabilrohr	17 to 63	8,0	39,5	EI 120
KeKelit	KELOX KM 110	16 to 75	8,0	40,5	EI 120 <sup>2</sup>
		75	9,5	40,5	EI 180 <sup>2</sup>
Rehau	Rautitan Stabil	16 to 40	8,0	38,5	EI 90
TECE	TECEflex Verbundrohr	16 to 63	8,0	39,5	EI 120
Uponor	Unipipe Plus	16 to 32	8,0	35,0	EI 240 <sup>1</sup>
	Unipipe MLC	16 to 63	8,0	39,0	EI 120
Viega	SANIFIX	16 to 63	8,0	39,5	EI 120
	Fosta-Rohr	16 to 63	9,0	39,5	EI 120
	Raxofix	16 to 63	8,0	39,5	EI 240*

<sup>1</sup> EI 120 for zero distance, 400 mm first support

<sup>2</sup> EI 90 for zero distance, 400 mm first support

**Aluminium Composite Pipes, floor ( $\geq 150$  mm) - EI 120, U/C**

All specimens listed\*

Graph shows assessed insulation thickness ( $t_{DE}$ ) at certain pipe diameter ( $\varnothing d_C$ )

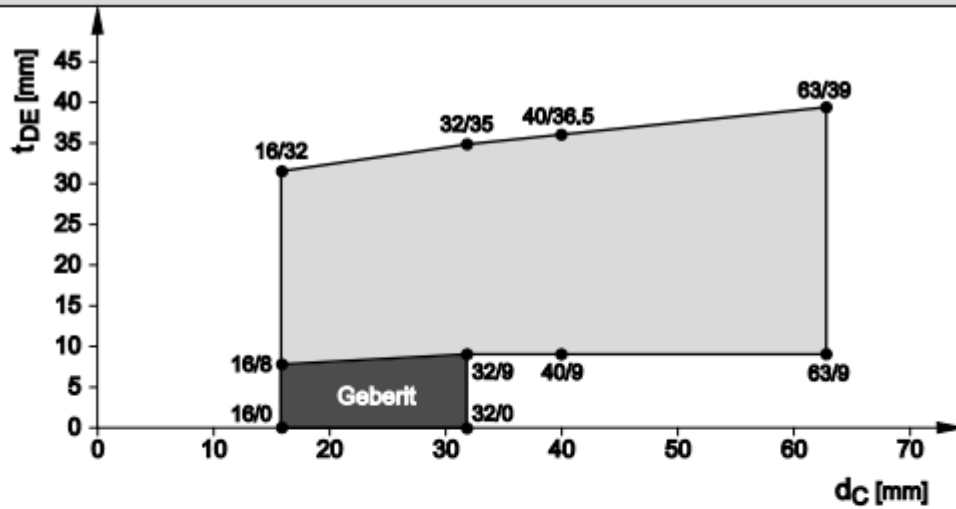

Graph shows results simplified, for all details see table.

**Aluminium Composite Pipes, floor ( $\geq 150$  mm) EI 90, U/C for Fränkische Rohrwerke, Geberit, Kekelit**

Graph shows assessed insulation thickness ( $t_{DE}$ ) at certain pipe diameter ( $\varnothing d_C$ )

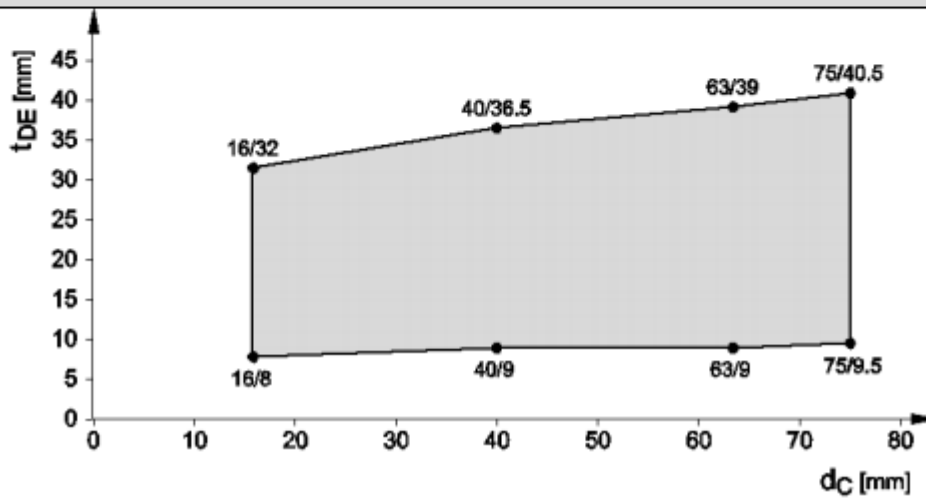

**C.2.3.4.2 Aluminium Composite Pipes insulated with protection pipe and or pre-insulated closed-cell PE foam**

Manufacturer	Product name	Pipe diameter dc (mm)	Insulation thickness (mm)		Classification U/C
			From	To	
<b>Geberit*</b>	Mepla pre-insulated	16 to 26	6,0	13,0	EI 120
<b>KeKelit Kelox</b>	Pro KM 130	14 to 32	9,0	9,0	EI 120
	Plus KM 134	14 to 32	4,0	9,0	EI 120
	Pro KM 140	16 to 20	PE HD	tube	EI 120
	Plus KM 144	16 to 20	4+ PE	HD tube	EI 120
<b>Uponor</b>	Unipipe plus	16 to 25	4,0	10,0	EI 120
	Unipipe MLC	16 to 20	PE HD	tube	EI 120

### C.2.3.5 Plastic Pipes

#### C.2.3.5.1 Plastic pipes made of PE-Xa (EN ISO 15875) and PE (EN 12201-2)

Service	Pipe diameter $d_c$ [mm]	Pipe wall thickness $t_c$ [mm]	Insulation thickness $t_{DE}$ [mm]		Classification -
			from	to	
PE-Xa Rautitan Flex	16 to 63	2,2 to 8,6	8,0	39,0	EI 180
PE / XSC 50 Wavin TS PE 100	50 to 110	4,6 to 10	9,0	42,5	EI 180

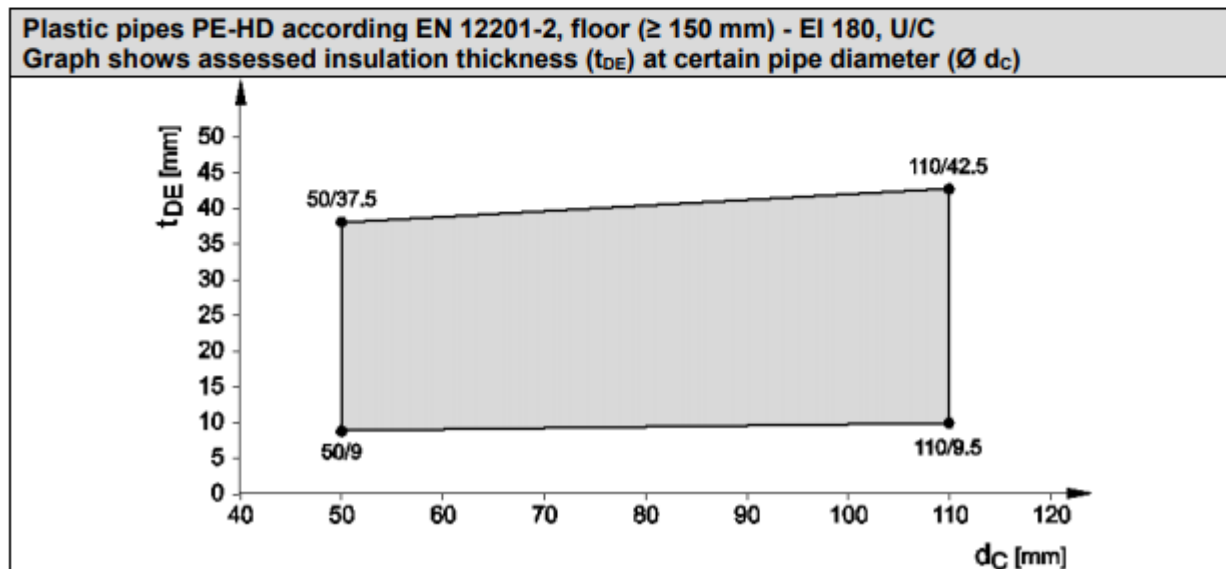
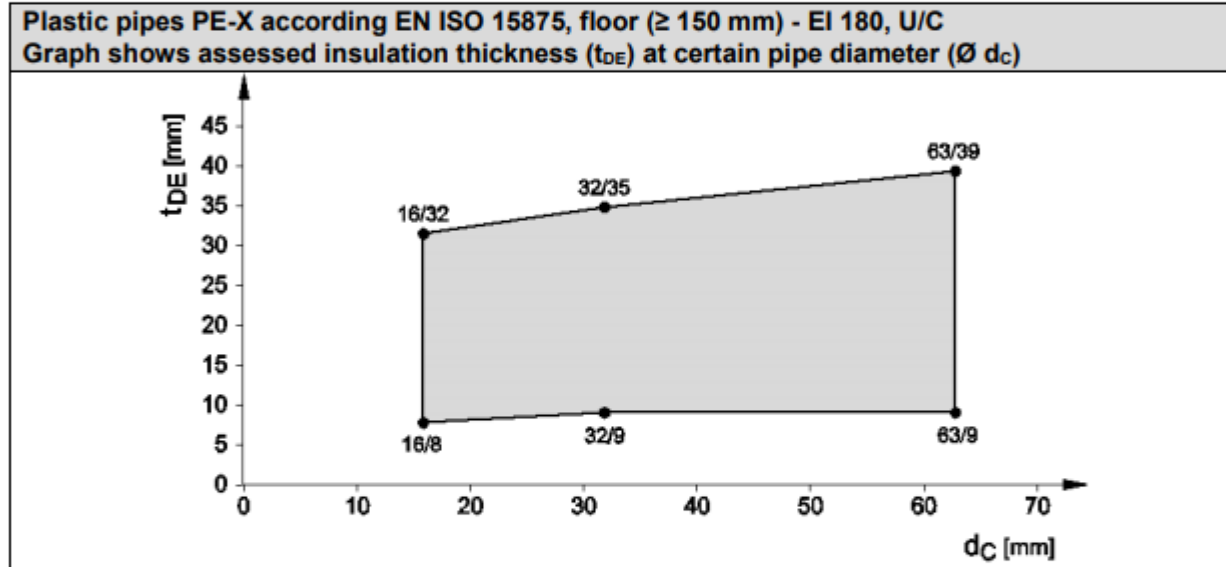



### C.2.3.5.2 Plastic pipes made of PP-R

Plastic pipes are continued, sustained (CS) insulated with elastomeric thermal foam.

Manufacturer	Product name	Pipe diameter dc (mm)	Wall thickness (mm)	Insulation thickness (mm)		Classification U/C
				From	To	
Aquatarm	Green <sup>1,3</sup>	20 to 110	1,9 to 10	8,0	40,5	EI 240*
	Blue <sup>1,3</sup>	20 to 110	1,9 to 10	8,0	40,5	EI 240*
Poloplast	Polo-Polymutan ML5 <sup>2</sup>	20 to 75	2,8 to 10,3	8,0	40,5	EI 240*
	Polo-Polymutan <sup>3</sup>	20 to 75	1,9 to 6,8	8,0	40,5	EI 240*
	Polo-Tersia <sup>3</sup>	20 to 75	1,9 to 12,5	8,0	40,5	EI 240*
Kekelit Ketrax	Cryolen Polyolefinblend <sup>1</sup>	20 to 75	1,9 to 6,8	8,0	40,5	EI 240*

\* for zero distance and / or 400 mm first pipe support classification is EI 120 U/C

<sup>1</sup> according EN 15874

<sup>2</sup> according ISO 21003

<sup>3</sup> according DIN 8077/78

## ANNEX D

### ABBREVIATIONS USED IN DRAWINGS; LIST OF ELASTOMERIC BUTYL RUBBER BASED FOAM INSULATION

Abbreviation	Description
A	Hilti Firestop Bandage CFS-B
A <sub>1</sub>	Annular gap seal with Hilti Firestop Acrylic Sealant CFS-S ACR
A <sub>2</sub>	Annular gap seal with gypsum plaster
A <sub>3</sub>	Annular gap seal with cementitious mortar acc. EN 998-2, group at least M2
C	Service (metal, composite, plastic pipes)
D <sub>E</sub>	Pipe insulation, combustible, butyl based elastomeric foamed material
d <sub>C</sub>	Pipe diameter (nominal outside diameter)
E	Building element (wall, floor)
s <sub>1</sub>	Minimum distance between single insulated pipes
s <sub>2</sub>	Minimum distance between clustered pipes
s <sub>3</sub>	Minimum distance between penetrating pipe and building element
S <sub>4</sub>	Minimum distance between single insulated pipes and Collar CFS-C SL
S <sub>5</sub>	Minimum distance between single insulated pipes and Conlit shell or Klimarock
t <sub>C</sub>	Pipe wall thickness
t <sub>DE</sub>	Insulation thickness
t <sub>E</sub>	Thickness of the building element
L <sub>D</sub>	Length of Insulation
AP1	Additional protection by elastomeric, butyl rubber based insulation
AP2	Additional protection by mineralwool (Klimarock)
AP3	Additional protection by beading / outside framing

#### List of assessed elastomeric butyl rubber based foam insulations:

Producer	Assessed Type of foamed elastomeric thermal isolation
Armaceff GmbH	• <sup>2</sup> Armaflex AF, <sup>3,4</sup> Armaflex SH, <sup>1</sup> Armaflex Ultima, <sup>6</sup> Armaflex HT
NMC Group	• <sup>3</sup> Insul-Tube (nmc), <sup>3</sup> Insul-Tube H-Plus (nmc),
Kaimann GmbH	• <sup>2</sup> Kaiflex KK plus, <sup>4</sup> Kaiflex KK,
L'Isolante K-Flex	• <sup>1</sup> l'Isolante K-Flex HT, <sup>5</sup> l'Isolante K-Flex ECO, <sup>2</sup> l'Isolante K-Flex ST, <sup>3</sup> l'Isolante K-Flex H, <sup>2</sup> l'Isolante K-Flex ST Plus

<sup>1</sup> BL-s1, d0; <sup>2</sup> BL-s2, d0; <sup>3</sup> BL-s3, d0; <sup>4</sup> CL-s3, d0; <sup>5</sup> DL-s2, d0; <sup>6</sup> DL-s3, d0 according EN 13501-1